



# CONCRETE SIKA SPRAYED CONCRETE HANDBOOK

BUILDING TRUST



# **Sika Sprayed Concrete Handbook**

---

# FOREWORD

Sprayed concrete is a rapid hardening material used for the stabilization and repair of structures by concreting without molds. It is probably one of the most sophisticated applications of concrete, where a perfect interaction of man, machine and the concrete mix is a prerequisite.

Man, especially represented here by the nozzle men, requires technical knowledge and practical skills, with experience and an affinity for this technology. The nozzle man must then be able to fully rely on the spray machine and the shotcrete base mix. It is this interaction and the quality of each individual component that finally determine the success of the sprayed concrete application.

Since its first edition in 2004, this handbook is intended to be a useful introduction to the basics and some of the key aspects of shotcrete technology, as well as a concise reference book for everyday support in the design and installation of shotcrete works. With this third edition, the Sika Sprayed Concrete Handbook continues this tradition with updates and additions, particularly regarding raw materials and shotcrete-specific mix design issues.

The aim is to provide the reader with a comprehensible guide of the most relevant topics and requirements as the basics for practical applications of shotcrete. This should be useful and provide answers and assistance to questions from everyday life and working, without going into too much of the respective scientific details.

Editor  
Sika Services AG  
Tüffenwies 16  
CH-8048 Zürich

Authors  
Dr. sc. nat. Benedikt Lindlar, Sika Services AG  
Dipl.-Ing. FH Markus Jahn, Sika Services AG  
Dipl.-Ing. HTL Jürg Schlumpf, Sika Services AG

Layout  
Sika Services AG  
Corporate Marketing Service

© 2020 by Sika AG  
All rights reserved

Edition 2020

# CONTENT

---

<b>FOREWORD</b>	<b>3</b>
-----------------	----------

---

<b>1 INTRODUCTION</b>	<b>7</b>
-----------------------	----------

---

<b>2 USES OF SPRAYED CONCRETE</b>	<b>13</b>
2.1 Excavation stabilization	13
2.2 Lining	16

---

<b>3 SPRAYED CONCRETE REQUIREMENTS</b>	<b>21</b>
3.1 Sustainability	21
3.2 Shotcrete mix	22
3.3 Application and freshly applied shotcrete	24
3.4 Matured shotcrete	26

---

<b>4 SHOTCRETE MATERIALS</b>	<b>29</b>
4.1 Aggregates	29
4.2 Cement	31
4.3 Water	32
4.4 Additives	33
4.5 Sprayed concrete admixtures	36
4.5.1 Superplasticizer	37
4.5.2 Setting retarder / consistency stabilizer	38
4.5.3 Setting and hardening accelerator for shotcrete	38
4.6 Fibers in sprayed concrete	46

---

<b>5 SHOTCRETE DEFINITION BY MATERIALS</b>	<b>51</b>
5.1. Wet sprayed concrete	52
5.1.1 Wet sprayed concrete mix design	52
5.1.1.1 Aggregates grading	56
5.1.1.2 Fines and paste	58
5.1.1.3 Batching Water	61
5.2. Dry sprayed concrete	64
5.2.1 Dry sprayed concrete mix design	64
5.2.2 Earth-moist shotcrete	65

---

<b>6 SHOTCRETE DEFINITION BY PROCESS</b>	<b>67</b>
6.1 Dense flow process	69
6.1.1 Advantages	70
6.1.2 Equipment for the dense flow process	70
6.2 Thin flow process	71
6.2.1 Advantages	72
6.2.2 Equipment for the thin flow process	73

---

<b>7 SPRAYED CONCRETE APPLICATION</b>	<b>75</b>
7.1 Health and safety	75
7.1.1 Environment, health, safety (EHS) for cement	75
7.1.2 EHS for the base mix	76
7.1.3 EHS for shotcrete admixtures	76
7.1.4 Application with heavy equipment	76
7.1.5 Shotcrete for excavation stabilization	77
7.2 Substrates	77
7.3 Spraying	78
7.4 Nozzle configurations	82
7.5 Rebound	84
7.6 Dust development	85
7.7 Spray shadows with wire meshes	86
7.8 Layering, lamination and cold joints	86

---

<b>8 SHOTCRETE QUALITY MANAGEMENT</b>	<b>89</b>
8.1 Raw materials and shotcrete quality	89
8.2 Quality control on site	92
8.2.1 Strength classes and performance of young shotcrete	93
8.2.1.1 Needle penetration method	95
8.2.1.2 Stud-driving method (HILTI)	96
8.2.1.3 Drill core method	96
8.3 Quality control at the laboratory	97

---

<b>9 TROUBLESHOOTING GUIDE</b>	<b>101</b>
--------------------------------	------------

---

<b>10 STANDARDS AND GUIDELINES RELATED TO SHOTCRETE</b>	<b>103</b>
---	------------

---

<b>11 INDEX</b>	<b>107</b>
-----------------	------------



This method can be used to convey any spraying material to a nozzle to be sprayed, e.g. from wet to oven-dry ready-mixed mortars and can therefore be used for:

- Dry sprayed concrete
- Earth-moist sprayed concrete
- Wet sprayed concrete

The more recently developed dense flow process (Figure 1.2) is very similar to pumped concrete, a pumpable wet shotcrete base mix is conveyed to the nozzle and from there it is transformed into shotcrete by means of compressed air. This process is only suitable for wet sprayed concrete.

In both spraying processes, the base mix passes through the nozzle at very high speed (ca. 30 – 40 m/s). The jet is formed and the other relevant constituents of the mix are added, such as water for the dry sprayed concrete, compressed air for the dense flow process and shotcrete accelerators if required. Subsequently, the sprayed concrete mix is projected onto the substrate at high velocity, which brings about the continuous formation of a fully compacted shotcrete structure on the substrate. This results in a great advantage over conventional concreting methods: Concreting without formwork.

The high impact energy of the sprayed material causes a good bond to the substrate. Due to the high kinetic energy of the sprayed material, initially all coarse aggregate in the first pass is lost as rebound. In this way, a thin layer of the remaining sand and binder paste forms at the interface, which is also forced by the pressure into the smallest cracks and voids in the substrate surface, creating an excellent bonding layer.



Fig 1.1: Shotcrete by thin flow process

Apart from this beneficial effect of rebound for achieving a bonding layer during the initial phase of spraying, rebound is generally subject to unwanted material loss and costs. Therefore, economic and technical considerations have led to limiting the largest grain size of such shotcrete, typically to 8 mm. Since the kinetic energy of particles increases with their radius to the power of three, larger aggregates are a very disproportionate part of rebound. Limiting the mix design to 0-8 mm reduces the rebound, e.g. to less than 10 % for wet sprayed shotcrete, and the shotcrete also gets a fine and uniform surface finish that can satisfy aesthetic and technical requirements without any additional fine layer being required, e.g. as a membrane carrier layer for tunnel construction.

Shotcrete technology has been further developed and improved significantly in recent decades. With respect to the volumes of sprayed concrete, the markets and technology have shifted from dry spraying to wet spraying. However, this does not mean that more modern wet spraying is going to replace the older method of dry spraying, as both have developed for different applications and requirements. In recent years, the two methods have been positioned side by side. Since the thin flow equipment is much smaller and easier to operate, dry spraying is mainly used for the application of smaller quantities, e.g. in repair and special works such as building swimming pools or so-called earth houses. Wet spraying, on the other hand, is predominantly used in tunneling and mining, where large quantities of shotcrete must be applied in a short time, e.g. for rock stabilization. Typical dense flow spraying machines have a nominal spraying capacity of up to 30 m<sup>3</sup> per hour.

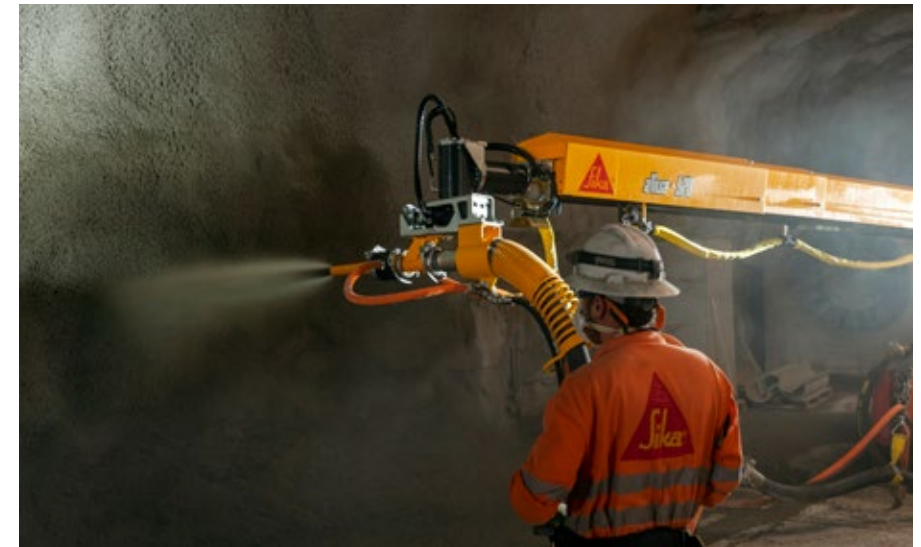

Fig 1.2: Shotcrete by dense flow process

Table 1.1: Key issues of shotcrete

Spray application	<ul style="list-style-type: none"> <li>■ Concreting without formwork</li> <li>■ Application in places that are difficult to access</li> <li>■ Variable shape and dimensions of shotcrete</li> </ul>
General requirements	<ul style="list-style-type: none"> <li>■ Must be steadily conveyable (pumping / spraying)</li> <li>■ Good mixing at the nozzle to avoid layering / lamination</li> <li>■ Good self-compaction by the spray jet</li> <li>■ Good adhesion to substrate</li> <li>■ Low rebound generation</li> <li>■ Low dust development</li> <li>■ High early strength development</li> </ul>
Special requirements	<ul style="list-style-type: none"> <li>■ Adjusted workability (prolonged open time)</li> <li>■ Increased load-bearing capacity</li> <li>■ High durability (strength, chemical resistance, fire resistance)</li> <li>■ High density/ low leachability (reduced tunnel drainage maintenance)</li> <li>■ Adequate ultimate strength</li> <li>■ Carrier layer for membranes (smooth surface)</li> <li>■ Sustainability</li> </ul>

Not only the spraying technology has changed in recent years. Efforts have also been made to improve the safety of people and the environment. For example, the highly alkaline stiffening and hardening accelerators for shotcrete have been replaced by modern alkali-free accelerators. The latter are far less dangerous in contact with human tissue and additionally, due to their lower alkali content, the durability of the shotcrete is significantly higher. Since nowadays much larger quantities are applied than before, mechanical spray arms are used. This allows the nozzle operator to work a few meters away from the nozzle and in a far safer working area than the immediate excavation zone in tunneling. Thus, robotized spray application has greatly improved worker safety.

The development of admixtures and additives for shotcrete also plays an important role. As already mentioned, new shotcrete accelerators have increased occupational health and safety. At the same time, these developments have meant that less chemicals are needed for the same effects. This reduction in shotcrete accelerators has also significantly increased the durability and final compressive strength of sprayed concrete. In addition, superplasticizers of the latest generation not only reduce the water requirement and increase workability, but are also matched to the shotcrete accelerator and the binder to achieve optimum shotcrete performance. Furthermore, the new SC-range superplasticizers reduce pumping pressures in the equipment and due to the better flowability and additionally entrained air, thus, improve the mixing of the accelerator into the shotcrete at the nozzle.

Synthetic fibers are increasingly being used instead of steel fibers to improve the load-bearing capacity of shotcrete. Two key advantages of synthetic fibers are that they do not corrode and there is no risk of injury if fibers protrude from the shotcrete. For this reason, a shotcrete modified with synthetic fibers can be used directly as a membrane carrier layer without having to be over-sprayed with plain shotcrete layer, as is the case with steel fibers. One possible disadvantage is their lower creep resistance, however, this plays a subordinate role in tunnel construction, since the excavation stabilization with shotcrete is often temporary and is covered with the load-bearing structural inner ring concrete in the course of the project.

In contrast to normal concrete, the high demands on strength development, the larger surface area of the aggregate and the immediate adhesion to the substrate require a higher binder content. For economic reasons, increased requirements in terms of durability (eluate) and sustainability, the cement content has been steadily reduced in recent years and partially replaced by additives such as fly ash. Whereas in the 1990s about 450 kg of cement (OPC) were typically used per cubic meter, clinker contents in shotcrete binder systems of only 300-400 kg/m<sup>3</sup> have become common, today.

In conclusion, from today's point of view, shotcrete is a flexible, economic and fast construction method, but it requires a high degree of mechanization and trained nozzle operators.



Fig 1.3: Shotcrete application, high degree of mechanization



## 2 USES OF SPRAYED CONCRETE

High flexibility, good cost-effectiveness and good physical properties open up a wide range of applications for shotcrete. However, by far the largest volume is used today in tunneling and mining, where the advantage of overhead spraying has led to new methods of securing excavation zones.

Table 2.1: Uses of sprayed concrete

Application Area	Example
Stabilization	Excavation stabilization in tunneling and mining Trench and slope stabilization
Lining	Shotcrete lining - of complex geometries at tunnel widening - in short tunnels and hard rock - in places with difficult access
Sealing	Temporary spray sealing of the excavation in tunneling Permanent sealing of old tunnels Sealing carrier layer for membranes
Refurbishment	Concrete repair of existing damaged bridges, quays, and piers Masonry repair of existing damaged tunnels and retaining walls
Construction	Earth houses built of shotcrete Swimming pools and skate parks
Creative work	Artificial rock landscapes for zoos Sculptures made of shotcrete

### 2.1 EXCAVATION STABILIZATION

The main application fields for shotcrete are in tunneling and mining. Most of it is used to provide temporary support to fresh excavations in order to maintain the stability of the excavation and to control the deformations of the rock. The great advantage of shotcrete is that it quickly forms a dense bond with the rock surface, which limits further settling and movement, and it can also be used in combination with other stabilization techniques such as rock bolts/anchors, steel nets, arches or lattice girders. Thus, the shotcrete has become important as element in conventional construction method, such as the New Austrian Tunneling Method (NATM).

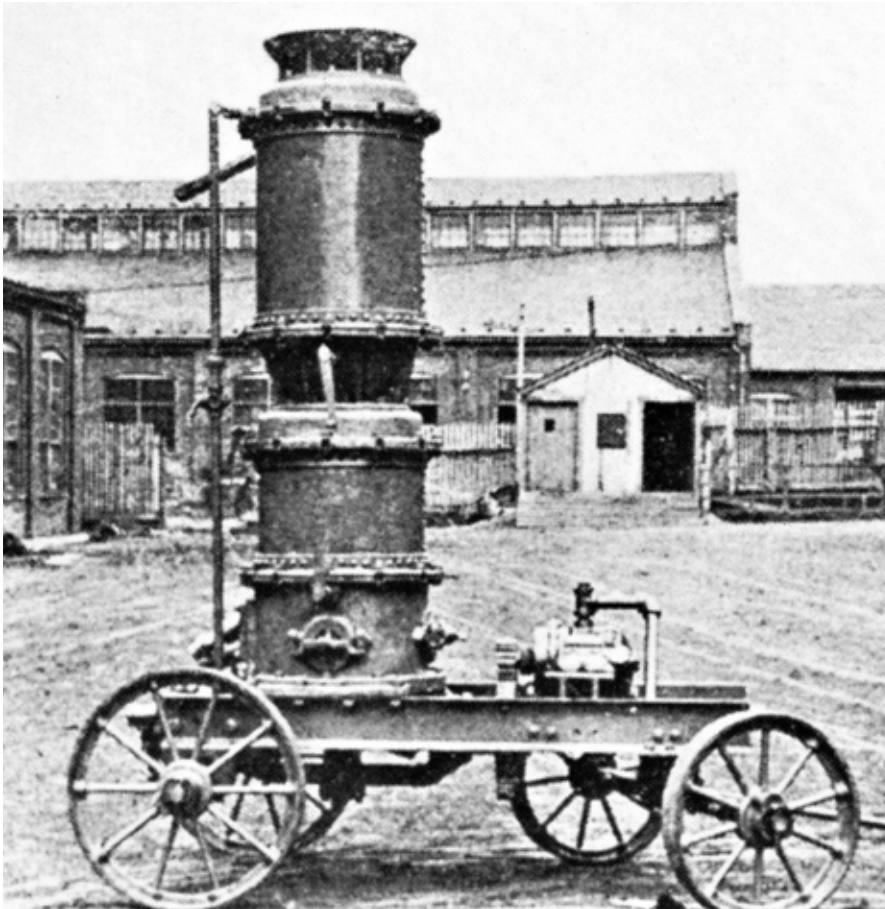

Fig 1.4: First Model of the Cement-Gun, 1910

Foto: J. J. Shideler, Portland Cement Association, USA.

In Pietro Teichert, Die Geschichte des Spritzbetons. Schweizer Ingenieur und Architekt, 47, 1979.



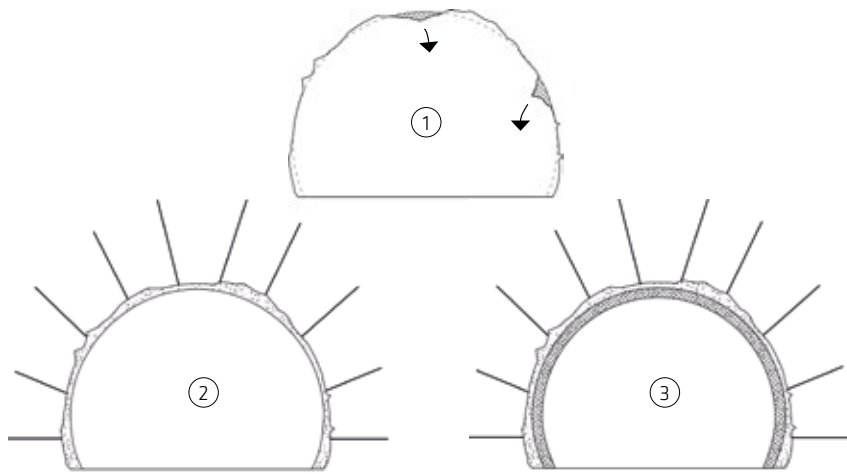

Fig 2.1: Main tunneling steps: Excavation and profiling (1), stabilization with shotcrete and rock bolts (2), lining with concrete (3)

Stabilization is based on the principle of penetration into existing surface voids and cavities. Shotcrete, respectively its fine components, penetrate into any voids or cavities in loose rock, as well as into cracks, fissures and layer joints of solid rock. In this way, friction between fractured rock layers is maintained by preventing washing out of rock fines (sealing) and by introducing additional paste material. The structure of the rock in the excavation area significantly improves and resists further loosening pressures. In addition, even a thin layer of shotcrete protects moisture-sensitive rock from weathering by the tunnel ventilation.



Fig. 2.2: Excavation stabilization with shotcrete

The formation of a structural shotcrete shell can create a load-bearing vault or bearing panels in combination with anchors, which can then be combined with other lining elements if required. As the stability of the rock decreases, the effort involved in securing the excavation increases. For example, if the rock is stable, excavation stabilization is generally not required, so that shotcrete is only used as head protection against rock fall. On the other hand, the required combination of rock reinforcement, e.g. shotcrete, anchors, and steel arches are used more extensively, the weaker the rock conditions are. In many cases nowadays fibers are added to improve the load-bearing capacity of the shotcrete lining, although it should be noted that either synthetic or steel fibers cannot reach the bearing capacity of heavier reinforcing steel.

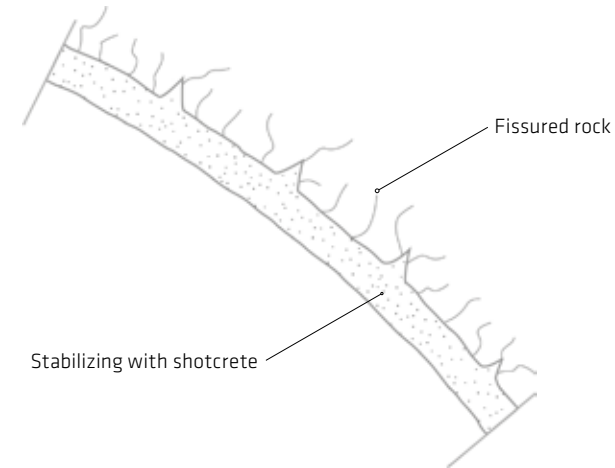

Fig 2.3: Stabilization by filling substrate cracks and building an arch of shotcrete and the surrounding rock

When used in combination with other stabilizing elements, the shotcrete lining is often applied in two steps. First, a thin 3-5 cm layer of shotcrete is applied to the freshly excavated rock surface. This layer serves as head protection to prevent rock fragments falling down as well as to strengthen the rock. Anchors and, eventually, reinforcement nets are then installed and a further 10-20 cm layer of shotcrete is applied to complete the excavation stabilization.

The structural lining of a tunnel can be carried out by creating one or two shells. With the double-shell lining method, the outer shell (excavation stabilization) is only regarded as temporary protection. However, the excavation stabilization layer may have to secure the cavity for several years until the concrete inner shell (tunnel inner lining) is put in place. With this double-shell lining method the outer shell is only partially counted or not even considered as a part of the structural design for the overall tunnel lining concept. This means that the inner ring has to be designed and constructed to ensure the long-term stability of the tunnel structure.

However, there are efforts where both shells are used for the static calculation of the tunnel lining. This concept is called single-shell construction. This allows to integrate at least part of the outer shell in the final lining allowing the wall thicknesses of the tunnel lining to be greatly reduced. The excavation stabilization layer is preloaded by the relaxation of the rock and groundwater pressure, which leads to a certain reduction of the requirements for the inner shell with regard to load-bearing capacity and waterproofness. When shotcrete is loaded over a short period of time at a young age, the final compressive strength is reduced compared to an unloaded shotcrete. For this reason and because of the lower quality of the first sprayed concrete layers (due to application condition and damages resulting out of the excavation process), an outer shell cannot be fully included in the overall concept of the lining protection.

## 2.2 LINING

The most common approach for the secondary lining in double-shell tunnels is to use in-situ concrete, cast-in-place with large formwork sections that are moved along for repeat pours on rails, usually these formwork sections are 8 m to 12.5 m in length.

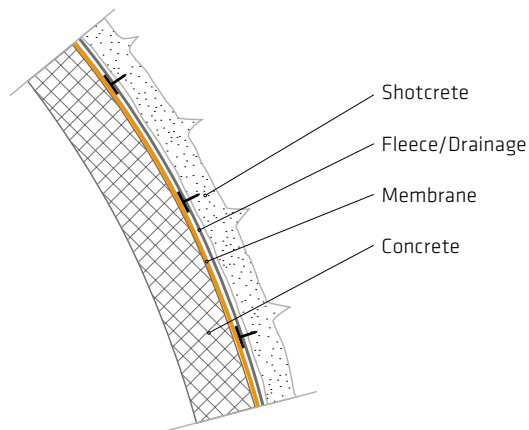

Fig 2.4: Double-shell tunnel lining

This approach provides a fast and economical solution for the regular cross sections of longer tunnels. However, there are some important technical and commercial limitations:

- In shorter tunnels, this expensive formwork might not be cost efficient.
- For changing geometries, widening sections, cross passages etc. this type of formwork is not suitable and either has to be modified for each pour, or replaced.

In these situations, a secondary lining made of shotcrete instead of in-situ concrete can be a more suitable system, with less complex operations and also the possibility of saving both time and money, because shotcrete does not require any formwork. This shotcrete method is a suitable replacement for most common inner concrete lining requirements and therefore can provide a solution to be applied in shorter tunnels, or wherever the cross section changes, e.g. in widenings, junctions, openings and cross passages etc.

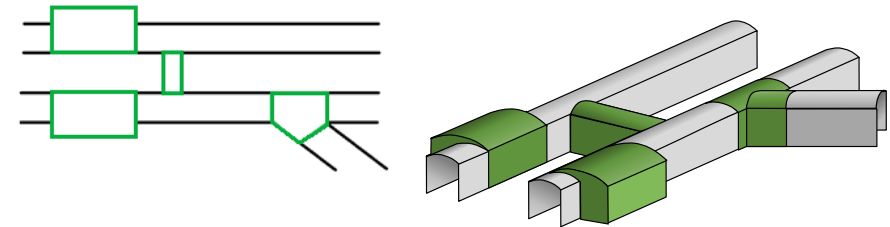

Fig 2.5: Scenarios of tunnel sections for formwork free shotcrete lining

The shotcrete for the secondary lining is applied inside the waterproofing layer on top of the membrane with the help of a special protective sheet and a rebound reduction net. The main drawback is that there is almost no adhesion between the smooth PVC or TPO waterproofing membrane layer and the freshly applied shotcrete layer. There is, therefore, a need to make some special arrangements.



Fig 2.6: Installation of a tunnel ceiling with variable shape by means of sprayed concrete onto membrane with the help of wire mesh (walls have been built with formwork and in-situ concrete)

In order to stabilize the shotcrete, almost without adhesion to the substrate, initially at the application area, narrow wire meshes are installed as rebound reducing system close to the membrane with the help of anchors. The free space between wire mesh and waterproofing membrane is designed to be about three times the biggest aggregate size (i.e. for 8 mm, so from 24 to 30 mm). The sprayed concrete is then applied in a grid-like pattern, with the mesh anchoring points sprayed and then these are joined, forming a grid (Figure 2.6). This procedure prevents the rebound mesh “flapping” and freshly applied sprayed concrete becoming detached. Finally, the compartments formed with the grids are filled to create a full surface layer of sprayed concrete. For the reinforcement layer spacers are attached to the anchoring points. Shotcrete is applied in the same way to cover this mesh as for the initial layer. After the second reinforcement, finally, the inner lining is covered with sprayed concrete and the surface is finished as required.

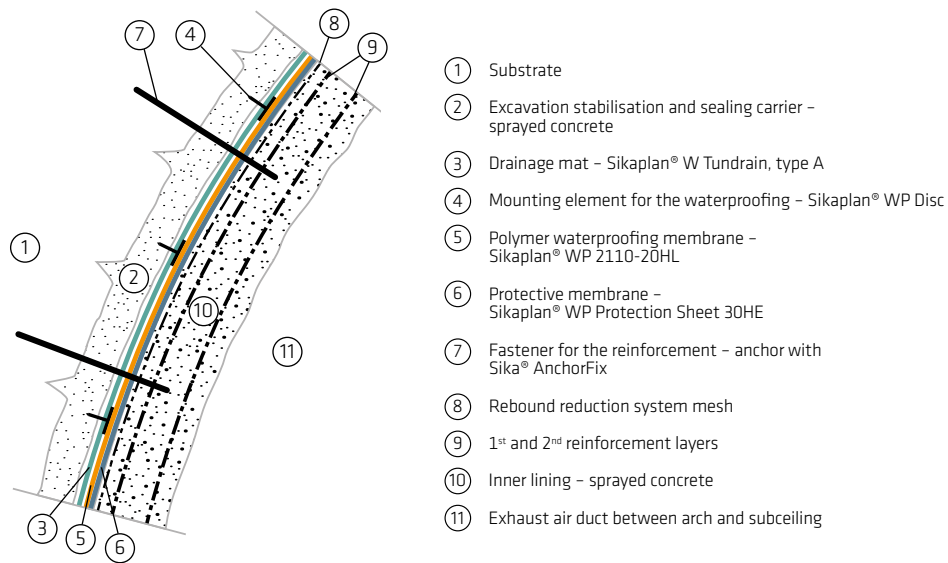

Fig 2.7: Double-shell tunnel lining with shotcrete

Apart from the use of membranes, the shotcrete lining itself can also be made waterproof to a certain extent. Shotcrete, like any type of concrete, is never completely waterproof on its own. Waterproofing of the excavation zone and the tunnel lining structure can be achieved to a certain extent by different approaches and the combination of different concepts and measures:

- **Pre-sealing (preventing water reaching the lining layer)**  
Depending on the quantity and pressure of water ingress, it can be stopped or drained with the help of previously installed sealing measures. Stopping the water ingress can be achieved by using injections (cementitious or resin types) to create a water barrier, or by a drainage system that is installed to drain away the water using drainage mats or pipes (e.g. Sika® FlexoDrain system).

- **Choice of materials**  
The mix design has to be specifically designed to produce a waterproof shotcrete, which must be confirmed before use both in the laboratory and in field tests with actual materials. All measures must be taken to ensure that the shotcrete is dense and crack free. A fundamental factor for the waterproofness of shotcrete is water reduction of the base mix. Any water, which is added in excess of the amount which is required for complete hydration leads to porosity of the final shotcrete and, thus, water-permeability. The use of superplasticizers is a must for this reason – as well as a reasonable water reduction is a prerequisite to achieve high early strength development and long-term durability of the shotcrete.

To achieve the optimum density of shotcrete, the entire mix design is a matter of concern, e.g. the cement type and content, the use of supplementary cementitious materials (SCM, e.g. silica fume), and the choice of an alkali-free accelerator. During the initial phase of a freshly applied shotcrete lining, cracks might form in the maturing shotcrete, which is another important aspect with regard to waterproofness. Again, the mix design plays an important role and there are also other precautions that must be taken to protect the surface from drying out and to reduce cracking, e.g. using micro synthetic fibers.

- **Admixtures enhancing the self-healing**  
The use of additional admixtures which enhance the self-healing of concrete cracks can be beneficial. SikaControl®-WT (e.g. Sika® WT-200 P) is used to support and promote the self-healing process of cracks. However, this type of admixtures can also influence the early strength development of shotcrete and have to be tested, accordingly.

- **Shotcrete application**  
A specific advantage of shotcrete application is the spraying process. When the shotcrete lining is applied, this is done in several thinner layers. Any early cracks that occur during the initial curing phase, e.g. two shotcrete layers are typically applied in intervals of few work shifts, these are then sealed with cement paste from the subsequent shotcrete layer. This minimizes cracks and, above all, prevents cracks that pass all the way through the entire shotcrete lining.  
In particular, when applying sprayed concrete through a reinforcing mesh, it must be ensured that no spray shadows are created behind the meshes. This requires a specially trained and skilled Nozzlemaster, as well as good base mix properties, e.g. a free-flowing mix.

In the same way that shotcrete is not just a product of its raw materials, but the outcome of combining materials, equipment and application, also its waterproofness – as part of its quality – depends on this same combination of the qualities of each individual part as a holistic system.

# 3 SPRAYED CONCRETE REQUIREMENTS

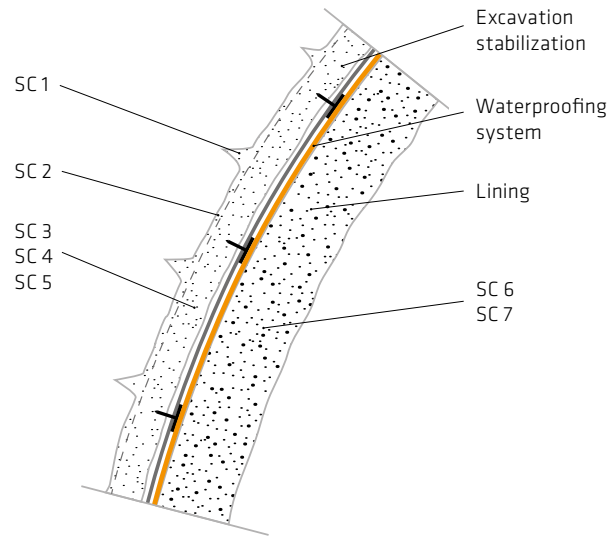

Fig 2.8: Purpose of shotcrete application and its classification according to SIA 198 (Switzerland)

Table 2.2: Quality specification of shotcrete in the construction of tunnel linings according to SIA 198 (Switzerland)

Sprayed Concrete Class	Compressive Strength Class	Exposure Class	Recommended areas of application
SC 1	C16/20	X0	Filling of joint fissures and cavities
SC 2	C25/30	X0	Immediate support
SC 3	C25/30	XA1, XD1	Further layers of the temporary support; respectively, first layer, if there are no special requirements regarding immediate support
SC 4	C30/37	XA1, XD1	Temporary support for single-shell lining, reinforced
SC 5	C30/37	XA2, XD1	
SC 6	C30/37	XA1, XD1, XC3, XF3	Lining for single-shell lining, reinforced or unreinforced
SC 7	C35/45	XA1, XD3, XC3, XF3	

Depending on its use, e.g. as slope or as excavation stabilization, and on the engineering demands of the structure as either temporary or permanent lining, the requirements for the shotcrete differ a lot. Thus, each individual project situation needs an individual definition of all relevant parameters that will affect the properties and requirements of the shotcrete through all different stages and states from fresh to finally hardened shotcrete. It is essential to know the exact needs of the individual site as otherwise it is obviously impossible to define the right materials, mix design, or type and placement method of the shotcrete.

Apart from the technical parameters as detailed, below, there are other general prerequisites and requirements, which designers also have to consider when looking at the entire shotcreting process. These additional parameters include the relevant local Environment, Health & Safety (EHS) regulations, for the highly specific application of shotcrete, especially regarding to the materials and the processing.

## 3.1 SUSTAINABILITY

Sustainability is a far-reaching term which, of course, primarily refers to materials. In connection with shotcrete and its specific fields of application, however, it is essential to consider the entire life cycle of the shotcrete components: from the raw materials, through the fresh concrete and its processing, to the finished construction and its maintenance effort over the entire service life. Consequently sustainability in relation to shotcrete becomes a more holistic issue and is closely related to many technical requirements, as described in the following sections with regard to the entire life cycle of shotcrete.

The shotcrete technology itself, is a method to place concrete very efficiently, i.e. quickly, with little effort and very selectively. This, too, is a contribution to sustainability, not least due to the fact that shotcrete used in underground construction ensures the quickest and best possible stabilization of underground excavation zones with minimum material input. Losses due to rebound material on spraying are brought to a minimum with the use of alkali-free accelerators.

Recent trends in shotcrete consider sustainability with respect to the CO<sub>2</sub> footprint by using blended cements or blended binder systems. Furthermore, using crushed aggregates instead of natural sand and gravel reduce the consumption of limited, natural resources.

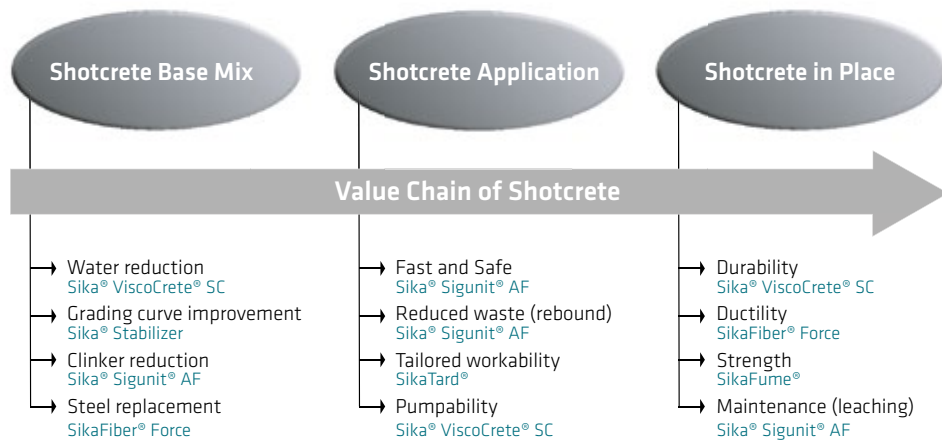

Fig 3.1: Impact of shotcrete products on sustainability

Modern admixtures make an important contribution to ensure that the properties regarding processability and shotcrete quality can also be achieved at a high level with these raw materials. Sika® ViscoCrete® superplasticizer, amongst others, effect easy pumpable shotcrete mixes of highest quality, thereby saving energy and resources.

Finally, during the long lifecycle of underground shotcrete structures, the maintenance efforts and cost play a major role for the sustainability aspect of shotcrete. Shotcrete is increasingly being used as permanent instead of temporary lining. It is again the admixtures that make a significant contribution to this trend by enabling highly durable shotcrete, independently from changing raw materials: With the help of Sika® ViscoCrete® superplasticizers for a maximal water reduction and Sika® Sigunit® AF alkali-free accelerators for high final compressive strength, highly durable shotcrete with low porosity, minimal leaching and chemical resistance to the ground water can be achieved.

Last but not least, workers safety and health has to be considered as integral part of the sustainability assessment. The trend to the recent alkai-free accelerator technology in shotcrete substantially improved the safety at work due to a more health-compatible material to deal with, lower dust emission during spraying and a uniform, continuous compressive strength development in young shotcrete, which is evident for the safety in the workplace.

## 3.2 SHOTCRETE MIX

In a first approximation, the requirements for the shotcrete base mix are based on the processing method of the shotcrete, i.e. by the thin- or dense flow method. In this regard, the requirements for a wet shotcrete base mix, in particular, must be closely observed and these are described in more detail below.

However, the close interdependency of materials and processing can also be seen here and the requirements with regard to processability also have a direct effect on the quality of the finished shotcrete.

The wet base mix for shotcrete has to achieve:

- Workability time:** Apart from the distance between batching plant and job site, there are many other reasons for potential delays right through the entire workflow, e.g. waiting times, installation gaps for other trades, equipment breakdowns and work breaks on site. An optimal time schedule for shotcrete deliveries, therefore, generally means that the shotcrete base mix is delivered on site as early as possible after the excavation and scaling but then it should remain workable for at least two to three hours later.
- Pumpability:** Pumpability of shotcrete is based on the well balanced combination of three features:
  - Viscosity = fluidity**  
 Of course, the mix must be liquid enough to flow through piston pump and hoses of the system. A too high viscosity is therefore obviously an essential exclusion criterion for the pumpability of the shotcrete. Conversely, while low viscosity allows the general flowability of the mixture, it is not a guarantee of pumpability, i.e. flow under the specific conditions that arise, such as high pressures and narrow, winding pipelines. The following two parameters must therefore also necessarily be fulfilled.



- Lubrication = friction reduction between aggregates (internal) and at the interface with the pumping lines**  
 The main volume share of shotcrete are the aggregates. While flowing (under pressure), they should move around each other permanently and with the least possible energy consumption, which is contrary to their nature. It is the paste of the shotcrete mix that creates this property by lubricating the surface of the aggregates and allowing them to slide past each other (see also Section 5.1.1.2). In addition, the paste also effects an external lubrication minimizing the friction between the mixture and the surface of the pipes.



- *Cohesion = maintaining a homogenous mix, non-separating and without bleeding*  
Both of the above-mentioned parameters, a reasonable fluidity of the mix (viscosity) and the lubrication of the aggregates, strongly depend on the enduring homogeneity of the mixture. The paste must not separate from the aggregates under the given conditions as well as the paste itself must not separate (bleeding).

- **Sprayability:** Apart from pumpability, the fresh shotcrete mix must also be able to pass smoothly through the nozzle, be well and easily dispersed to mix homogeneously with the accelerator before the final shotcrete is sprayed and compacted onto the substrate. Sprayability, characterized by flowability and low stickiness, is an important prerequisite for the optimal quality of the applied shotcrete.

### 3.3 APPLICATION AND FRESHLY APPLIED SHOTCRETE

The main objective for the freshly applied shotcrete is to rapidly secure underground excavations. Sprayed concrete technology provides an excellent material for this purpose, which develops early strengths quickly and, thanks to spray robot arms, this can now be achieved in a safe application method for the nozzle operator.

- **Low dust and rebound:** Dust formation during sprayed concrete applications is one of the serious health issues with shotcrete works. The spray dust consists of finest parts of the mixture (especially cement) as well as accelerator releasing with the secondary air. It is strongly alkaline/ caustic and accordingly harmful to eyes and respiratory tract (tissue irritation, silicosis, ...).  
Rebound adversely affects cost and time efficiency of the entire spraying process due to material loss, additional material transports, plus the additional waste materials disposal. Furthermore, there are the implications for a reduced shotcrete quality: Since the major part of rebound material is always going to be from the larger grain sizes, the composition of the shotcrete is substantially changed from its design concept and potentially its intended performance.

Various measures can be taken to reduce the dust and rebound problems:

- *Optimization of the mix design*  
An even grading of the aggregates is required for many reasons, however, a too large grain size would create strong rebound, thus, shotcrete is usually limited to 0-8 mm mixes. With its fines content aggregates contribute as well to the overall dust. The paste volume (binder, fines, water) beyond the required amount for lubrication just would create unnecessary more dust.
- *Reduction of spray rate (m<sup>3</sup>/h)*  
The spraying rate should not be used up to the equipment capacity limit. This would typically result to high losses of rebound, fall offs, and to low shotcrete quality (and definitively not to a maximal shotcrete application speed). Furthermore, high spray output dramatically increases the dust formation.
- *Reduction of compressed air*  
If the compressed air is not well balanced with the shotcrete output, excess of dust is caused.



- *Reduction of accelerator dosage*  
If the accelerator dosage is too high, the shotcrete stiffens too fast. Due to the friction at the nozzle as well as due to lowered adhesion to the substrate more dust is generated and the rebound increases.
- *Use of AF-accelerator instead of alkaline*  
Alkali-free accelerators instead of alkaline products reduce the caustic properties of the dust. This is especially related to the dust fraction originating from the air side stream. In addition, the initial stiffening is a bit more moderate with the AF-accelerators effecting a better adhesion of the fresh sprayed material and thereby less rebound.

- **Bonding to substrate:** An essential aspect of shotcrete is its strong adhesion to the substrate. This is important in order to make vertical and overhead applications possible in the first place. In addition, this strong bonding of the shotcrete with the substrate leads to a high load-bearing capacity of the shotcrete lining in combination with the substrate.  
When spraying starts either on the rock substrate or on a previous, hardened shotcrete layer the normally unwanted rebound supports the formation of a very strong adhesion layer. Due to the high kinetic energy of the sprayed material and its spraying onto a rigid, non-flexible substrate, all coarse aggregate in the first pass is lost as rebound. A thin layer of the remaining paste from sand and binder forms at the interface, which is also forced by the pressure into the smallest cracks and voids of the substrate surface, creating an excellent, cement-enriched bonding layer.

- **Compaction:** In the first few minutes after application of the sprayed concrete, the adhesive strength and compaction of the shotcrete are decisive. The accurate feeding of a reasonable amount of compressed air as well as an optimal distance of the nozzle to the substrate are the key parameters at this moment. The consequence of insufficient air is a too low concrete compaction, which in turn would negatively influence the final compressive strength. Too much air produces excessive dust plus increased rebound losses. Fine cement and accelerator particles lost as dust, are furthermore potentially important components that would be missing for optimal strength development. Accordingly, an incorrect nozzle distance, either too far or too close to the substrate, would lead to similar effects.

- **Very early strength** (stiffening/setting), up to ca. 2 hours from spraying: Whereas the shotcrete base mix must be fluid and pumpable, its consistency has to become stiff right after it has been sprayed. According to the individual site requirements (slope, excavation ...) the initial strength development is defined as three different J-classes according to EN 14487-1. In a J2 shotcrete, typically applied in overhead applications, up to 1.0 – 1.5 MPa are to be achieved within the first one to two hours.

- **Early strength**, 2 hours to 24 hours from spraying: Subsequent to the initial stiffening period (0 – 2 h) the compressive strength of the freshly placed shotcrete has to increase continuously. The early strength is, basically, achieved by the cement hydration reaction. The base mix comprises admixtures for the improvement of various properties (e.g. workability, pumpability, sprayability, durability), the retarding and liquefying effects of which are deactivated by the addition of the accelerator at the nozzle. Regarding safety on site, this period of 2 – 24 h is critically important. With a consequent compressive strength increase in the J2-range during this time period it can be considered that the cement hydration has sufficiently started, subsequently to the initial acceleration, which is crucial in order to prevent fall down of shotcrete.

### 3.4 MATURED SHOTCRETE

Depending on whether the shotcrete is used as a temporary lining shell or as the final lining shell, the requirements obviously vary, particularly with regard to its durability. However, any shotcrete lining must protect the excavation zone for a defined period of time and provide the corresponding static properties, be this for months, years or permanently.

- **Final compressive strength** The final strength of sprayed concrete is mainly determined by the type of cement and the general mix design, e.g. grading, water/cement-ratio (w/c-ratio), accelerator type. In underground construction, the usual demands regarding final compressive strength do not have priority for shotcrete, since the shotcrete is quite often only being used for temporary stabilization of the excavation. From all of the different admixtures that can be used, the superplasticizer (w/c-ratio) and accelerator type have the most major impact on final compressive strength.

- **Energy absorption** Depending on the geology and rock mechanics, the shotcrete is usually too brittle and requires reinforcement for adequate load-bearing behavior. This reinforcement can be achieved classically with wire mesh and/or steel reinforcement or as an inherent reinforcement by the addition of fibers into the mix during the base mix production.

- **Durability** There are many parameters, from the base mix materials to the nozzleman's skills that have a substantial impact on shotcrete durability, e.g. w/c-ratio, cement type and amount additives, grading curve, plus the quality of application. Durability is also a collective term involving several shotcrete properties:

- Waterproofness  
If the shotcrete is too permeable and/or the ground/mountain water pressure too high, water can penetrate the shotcrete structure. As a result of the water migrating into and out of the shotcrete, two types of degradation of the cement matrix become possible, either by chemical attack of dissolved substances from the surrounding underground water or by leaching chemical components from the shotcrete matrix.  
In this respect, the density of the shotcrete is a key factor for a durable shotcrete lining. Measures such as reduction of cement content, clinker substitution or the addition of additives (e.g. fly ash, micro silica), and reduction of the w/c-ratio are essential.
- Resistance against chemical attack  
In particular, it is sulphate attack which results in chemical degradation of cement hydrates, e.g. by delayed ettringite formation, which causes a mechanical force due to crystallization pressure, or by thaumasite formation resulting in the decomposition of the cement matrix. The shotcrete lining must withstand this type of attack, which is related to the chemical nature of the water from the tunnel surroundings. This is either brought about by a suitable choice of materials, e.g. using sulphate resistant cement (low C<sub>3</sub>A cement) and waterproofing measures like the reduction of the w/c-ratio and addition of silica fume.



Fig 3.2: Damage due to insufficiently durable shotcrete (e.g. crystallization pressure due to sulphate attack)



# 4 SHOTCRETE MATERIALS

- Resistance against leaching  
As a consequence to water migrating through the shotcrete matrix, the hardened cement paste is exposed to a constant dissolution process. In underground constructions the leaching water is drained away inside the tunnel where, in contact with air, the leached compounds from the cement precipitate and clog the draining system, over time. Leaching of shotcrete, thus, causes a strength reduction of the lining as well as constant cost for the functional maintenance of the draining system. The measures for preventing the leaching of shotcrete linings are essentially the same as for waterproofness, to improve the density of the shotcrete and to reduce the solubility of the binder system.
- Frost/freeze thaw resistance  
Inside tunnels, the freeze-thaw resistance of shotcrete is rather no issue. However, for slope stabilization or shotcrete applications in the tunnel portal area, shotcrete like any other concrete, must be able to withstand adverse winter conditions and measures have to be taken to this end. It is the crystallization pressure of freezing water inside the shotcrete matrix which is a cause of the frost damage. Accordingly, suitable measures to improve the resistance of shotcrete exposed to low temperatures are increasing its density/waterproofness in order to already prevent water from entering the structure. Furthermore, the introduction of small air voids improves the freeze-thaw resistance of shotcrete by creating space for the expansion of the freezing water inside the cement matrix. Specific air-entraining admixtures are available for this purpose.
- Fire resistance  
In concrete and shotcrete exposed to a fire, as the temperature rises above 100°C, the liquid capillary water (free water) and physically bound water (in gel pores and interstitial layers) suddenly changes to steam and a high pressure is building up inside the concrete. As soon as this pressure is higher than the internal tensile strength of the matrix the concrete fractures and spalls. As a result, shotcrete is continuously damaged during a fire and its structure can be destroyed. Polypropylene micro fibers (PP) are used in shotcrete for their anti-spalling effect in case of fire. With increasing heat the fibers melt and the appearing voids allow the release of the vapor pressure.

Shotcrete, as a special kind of concrete, is basically the combination of three materials, which in order of the quantities used are:

1. **Aggregates** (sand and coarse aggregates) as the main matrix of the shotcrete
2. **Cement** as the binder of the system, when combined with
3. **Water** for plasticity/pumpability and for the hydration of the binder

To extend its properties and potential applications, concrete can easily become a system of many more components (with additives, admixtures etc.), resulting in complex mechanical and chemical interactions, especially when combined with the application parameters for sprayed concrete:

4. **Additives** (micro fibers, silica fume, limestone, fly ash, slag)
5. **Admixtures** (superplasticizers, retarders, air-entrainers and shotcrete accelerators)
6. **Reinforcement** (steel or synthetic macro fibers)

All these base materials have an impact on one or another concrete property, as required for the shotcrete during its various states throughout the entire working process. Accordingly, the art of shotcrete is based on finding the right balance of all these ingredients in order to fulfil the given requirements – in combination with adequate application steps from batching to application.

## 4.1 AGGREGATES

The aggregates form the framework of the sprayed concrete matrix. Approximately 75 wt-% (64 vol-%) of the shotcrete consists of aggregate components. The properties of the aggregates (nature, shape, grading) have a huge influence on the workability and hardened shotcrete properties. They are sourced either naturally as rounded shape particles from rivers or glacial deposits or mined and crushed from quarries or excavation work.

Aggregates (fine and coarse):

- represent the major part of the concrete mix
- have a substantial impact on workability and pumpability
- influence the mechanical properties (tensile and compressive strength)
- influence the homogeneity of the sprayed concrete mix
- have a strong impact on the water demand of the base mix

Accordingly, aggregates should be carefully considered in shotcrete mix design regarding:

- Shape (rounded or crushed):  
Influences the flowability/pumpability of the mixture, its paste requirement and the mechanical properties of the shotcrete
- Grading curve:  
Affects pumpability as well as strength properties of the shotcrete
- Mineralogy and impurities (e.g. clay minerals, mica):  
Might cause due to adsorption effects a high water demand and reduced workability, a lower effectiveness of admixtures, and low final compressive strength



An important specialty of the shotcrete mix design compared to structural concrete is the aggregate's maximal grain size that is typically limited to 8 mm in shotcrete. The reason for this constraint is due to the spraying application: at the nozzle the material is accelerated to a velocity of about 30 m/s. The kinetic energy of particles is proportional to their radius to the power of three. Due to their higher kinetic energy, the fraction of repulsed particles becomes exponentially higher with increasing diameter, yielding in higher rebound and unnecessary costs (extra materials, time and effort). The grain size of shotcrete, limited to ca. 8 mm (in some regions up to 13 mm), is the accepted best compromise of an optimal space filling aggregate grading with minimal paste volume and a minimal rebound quantity (see Chapter 5.1.1, Wet Sprayed Concrete Mix Design).

## 4.2 CEMENT

By far the most important building material today is concrete. Cement, its binding agent, is produced worldwide with about 4.1 billion tons per year (2019). It belongs to the category of hydraulic binders, meaning that there is a water induced binding reaction, which yields a solidified end product (cement stone).

The term "cement" originates from the Roman's construction method "opus caementitium" (= works from rubble stone). More than 2000 years ago, they built impressive and extremely durable buildings not just by brick laying, but with the help of an initially plastic mix out of rubble, water and a mix of natural pozzolanes with burnt lime as hydraulic binder. Our modern Portland cement, which is the binder in concrete, received its name from this original name of the Roman concrete. It is based on clinker that is produced from limestone, marl and clay, which are burned at 1450°C in rotary kilns. During this process, chemically bound water and CO<sub>2</sub> are released from the raw materials and the remaining materials are sintered into new mineral phases that form the clinker granules.

Later, as binder in concrete, the cement comes into contact with the mixing water and absorbs part of it in a complex hydration reaction, over time. This hydration process is brought about by a dissolution (of the clinker phases) and precipitation (of cement hydrates) process. The newly crystallized hydrates build up a continuous, felt-like mineral solid which creates the interconnection of the aggregates. In this way, the concrete sets and hardens.

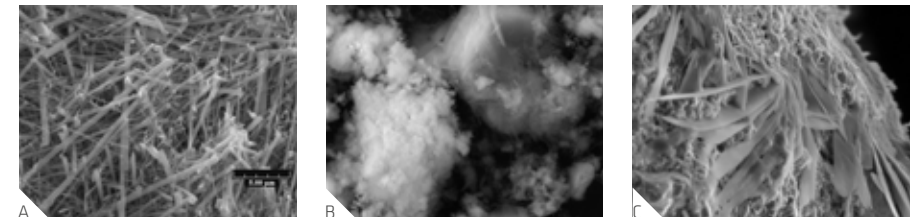

Fig 4.1: Scanning electron microscope images of A) ettringite (calcium aluminium sulphate hydrate), B) calcium silicate and calcium aluminate hydrates (CSH, AFm), and C) of portlandite (CH).

Features of shotcrete that are achieved with the help of the cement in the mix are:

- Plasticity/pumpability of the base mix  
The paste (including cement, additives, all fines from the mix design, and water) acts as the main lubricant. Cement is its predominant component and largely responsible for the rheological properties of the paste.  
The aggregate particles of the shotcrete mix are covered by the paste and can thus slide around each other. The base mix becomes a plastic, fluid material, which can be pumped. Furthermore, the paste is also important to lubricate the interface of the base mix with the pipes. In wet spraying, these lubricating effects are highly important for the concrete delivery to the nozzle.



#### ■ Bonding to the substrate

Since the shotcrete hits the substrate at a very high speed, initially all coarse aggregates bounce back and a thin layer of cement paste is initially formed, which acts as a bonding bridge between the substrate and the shotcrete shell. This paste is pressed into smallest cracks and voids, resulting in a strong bonding layer.

#### ■ Setting and hardening

Subsequently to the spraying, the cement paste acts as the “glue” of the applied shotcrete mix. It embeds and binds the matrix of aggregates within a short time and thereby contributes significantly to the mechanical properties in young and mature shotcrete.

For shotcrete, in contrast to ordinary concrete, the normal cement hydration reaction is additionally interlinked to the accelerator chemistry. The very fast acceleration reaction strongly depends on the reactivity of the cement and its cement solution in the fresh mix. Therefore, the cement has to be carefully approved for its suitability in shotcrete use.

Typically, the cement content in sprayed concrete is about 400 – 500 kg/m<sup>3</sup> (or up to ca. 100 kg replacement by additives). The exact binder amount is depending on the spraying process and the shotcrete requirements.

## 4.3 WATER

The third largest mass fraction of a shotcrete base mix is water. It affects mainly two issues:

- In the base mix water determines (together with the concrete admixtures) the concrete’s consistency/plasticity.

- In the applied shotcrete, water is both the reaction medium and a reactant of the chemical processes that cause the stiffening and hardening of the shotcrete, both the initial acceleration reaction and the ongoing process of cement hydration.

Depending on availability at the batching plant, the dosing water in shotcrete is obtained from:

- Tap water
- Recycling water
- Ground or natural surface water

Based on its source, the batching water can have an ionic contamination, which would then be introduced into the concrete. Hereby, the particularly sensitive chemistry of shotcrete acceleration and hydration might be adversely affected. Consequently, special attention has to be paid for contamination, which could adversely affect the shotcrete quality, including:

- |                      |   |
|----------------------|---|
| ■ Oil and grease     | → hydration retardation                           |
| ■ Chlorides          | → corrosion of steel reinforcement                |
| ■ Sulphates          | → disturbing acceleration and hydration reactions |
| ■ Ca- and/or Al-ions | → disturbing acceleration and hydration reactions |
| ■ Sugars             | → hydration retardation                           |
| ■ Salts              | → reducing durability                             |

Especially when sourcing water recovered from concrete processes on site (e.g. recycled water), the chemical properties of the water have to be monitored closely, as any substances dissolved in it, can vary considerably over time and might affect the chemism of acceleration and cement hydration.

With regard to the shotcrete quality and overall performance, the quantity and quality of the water must be absolutely taken into consideration.

## 4.4 ADDITIVES

Fine mineral additions to concrete are roughly divided into chemically reactive and chemically non-reactive additives. It should be noted, however, that no simple, clear distinction can be made between the chemical reactivity or non-reactivity of these additives in concrete. Rather, as can be seen from the pozzolanic additives mentioned in the following and also the new microcalcites, morphology and crystallinity have a significant influence on the individual reactivity.

### 4.4.1 REACTIVE ADDITIVES

Reactive additives or supplementary cementitious materials (SCM), either in addition or as replacement of part of the cement, contribute to the properties of concrete due to their hydraulic or pozzolanic properties. They are used for various reasons and, therefore, can differ considerably in their characteristics. They can be added to sprayed concrete in order to:

- Supplement the fines balance  $\leq 0.125$  mm for optimal paste volume (improved lubrication and pumpability)
- Improve durability (density, resistance to chemical attack)
- Increase the water retention capability (mix stabilization)
- Substitute part of the cement (reduced CO<sub>2</sub> footprint, cost optimization)

Many different types of chemically reactive fines are used. An important factor in selecting these additives are their costs or even their local availability. The following three are examples of commonly used reactive, siliceous additives. Due to their chemical nature they all exhibit pozzolanic or latent hydraulic chemical reactivity.

### Silica Fume

Silica fume is amorphous SiO<sub>2</sub>, which occurs as a by-product in the production of silicon. This extremely fine material has an enormous specific surface area and, due to this, is highly reactive. It improves the cohesion of the base mix, reduces the rebound during spraying, increases the final compressive strength and improves the durability of the applied shotcrete with respect to freeze-thaw resistance and chemical attacks.

### Fly Ash

Fly ash is obtained from the electric filters in hard coal-fired power plants. Its quality strongly depends on the type of coal used. Shotcrete with fly ash has improved workability and a reduced heat and strength evolution due to the pozzolanic characteristics of the fly ash. Due to its current availability and relatively low price, fly ash is frequently used to improve shotcrete durability.

### Slag

Slag or ground-granulated blast-furnace slag (GGBFS) is a very fine particle by-product from blast-furnaces during raw iron production. It is widely used as a shotcrete additive to reduce the cement cost and achieve higher shotcrete density, reduce permeability, and improve resistance to chemical attack. The early strength gain is slower with GGBFS.

## NEW TRENDS IN REACTIVE ADDITIVES

### Calcined Clays

Secondary raw materials are limited in terms of their availability in quantity and quality by the processes on which they are based. Alternative binder materials, nevertheless, should be cheap, easy and long-term available, and their sourcing should allow a reasonable clinker replacement in terms of shotcrete performance, sustainability and CO<sub>2</sub> reduction.

As a new type of reactive additives, calcined clays have recently attracted interest. Natural sources of mixed clays are globally available and exhibit good pozzolanic properties after a calcination process at about 700 – 800°C. In case of calcined clays, the significantly more moderate calcination conditions as well as the decarbonation avoided by these materials result in potential CO<sub>2</sub> savings of up to 30 %.

Up to ca. 25 % clinker can be replaced by this kind of SCM with no loss in cement reactivity but achieving same binder properties and higher durability. In combination with other additives like limestone and gypsum, the clinker replacement can be even increased to about 50 % with a still comparable strength development.

### Micro Calcite Filler

Especially under the specific chemical mechanisms of shotcrete the clinker replacement, e.g. by fly ash or slag, bears the risk of losses in initial shotcrete performance which is not or only to a limited extent acceptable for safety reasons.

Limestone filler which is typically considered as an inert additive might behave completely different when its particle size is substantially reduced in comparison to the usually used fillers. A so called “filler effect” can be observed especially in alkali-free accelerated shotcrete for micro calcite fillers with a mean particle size  $d_{50} \ll 10 \mu\text{m}$ .

These fine limestone fillers no longer act only as inert additives but also act as crystallization seeds and, due to their high specific surface, even chemically contribute to the reactions taking place during the early strength development of alkali-free accelerated shotcrete. Adverse effects of clinker replacements on the shotcrete performance thereby can be compensated, i.e. reduced initial stiffening and early cement hydration.

Table 4.2: Characteristics of chemically reactive additives in shotcrete

Mode of Action Effect on	Type	Hydraulic		Pozzolanic		Latent Hydraulic		Inert
		Cement	Silica Fume	Fly Ash (Type V)	Fly Ash (Type W)	Slag	Limestone Filler	
<b>Fresh Concrete</b>								
Handling		++	++	++	+++	+		+++
Water Retention Capacity		++	+++	+	+	+		++
<b>Compressive Strength</b>								
Very Early Strength 0-2h		+++	+	+	-	-		+/-
Early Strength 2-12h		++	++	+	-	-		+/-
Final Strength (90 d)		++	+++	++	++	+++		+/-
<b>Durability</b>								
Water Penetration Resistance		++	+++	++	++	++		+
Sulphate Resistance		-	++	+/-	+/-	+++		+/-
		Cement - type and quantity influence the workability and strength development.		"Improve the durability increase the bonding behavior and with it the mechanical properties. Reduce the pH value of the concrete interstitial water and should therefore be limited in quantity."		Slow down the strength development and increase the durability.		Do not themselves develop strength but help by improving the particle matrix.

+ improving - deteriorating

#### 4.4.2 NON-REACTIVE ADDITIVES

In contrast to the reactive additives, chemically inert filler do not react in the chemical environment of the concrete and do not interact with the cement hydration process. Typically, these are fine fillers such as quartz or limestone flour, which due to their particle size distribution are used to achieve a suitable fines content, or an optimized micro structure of the mix.

### 4.5 SPRAYED CONCRETE ADMIXTURES

Admixtures are used to improve and/or change shotcrete properties, which are otherwise difficult or impossible to control by the mere combination of cement, aggregate and water alone. The addition of admixtures to shotcrete takes place during the base mix batching. According to EN 206, admixtures can be added to the concrete at a maximum dosage of  $\leq 5\%$  by weight of cement (bwc). If the total amount of admixtures is beyond three liters per cubic meter of concrete, the water introduced by the admixtures also has to be considered in calculating the total water content of the concrete mix.

As a special feature with shotcrete, the accelerator, as an admixture, is only added at the nozzle during the spraying process. Its maximum dosage according to EN 934-5 is limited to 12 % bwc.

Table 4.3: Main properties of shotcrete and admixtures or additives to improve them

Sprayed Concrete Target Specifications	Control Parameters	Concrete Admixtures for Target Achievement
Compressive strength Flexural strength Durability	Set concrete characteristics	Superplasticizer Additives Fibers Curing agents
Pumpability Sprayability	Workability	Viscosity modifying admixtures Additives Superplasticizer
Strength development	Setting and hardening	Shotcrete accelerators Superplasticizer
Working time	Open time	Setting retarders

There are three key admixtures used in shotcrete: superplasticizers, retarders, and the shotcrete accelerators, which are crucially important regarding the handling, safety and final shotcrete quality. These three out of the wide range of admixtures available for shotcrete are described in more detail below.



#### 4.5.1 SUPERPLASTICIZER

Along with the shotcrete accelerator, the superplasticizer (high-range water reducer, HRWR) is the most important concrete admixture for use in wet sprayed concrete. The maximum water/binder ratio (w/b-ratio) is generally defined as 0.50, but a maximum w/b-ratio below 0.48 or less is preferred for optimum shotcrete performance and quality.

In addition, the workability time and internal cohesion of the fresh concrete are influenced by the high range water reducer. The composition of the superplasticizer, in particular the choice of the active polymer ingredient, also influences the performance of the shotcrete accelerator. For shotcrete dedicated superplasticizer are designed (Sika® ViscoCrete® SC range) to match the requirements of shotcrete, i.e. prolonged workability time, enhanced air entrainment, and pumpability. All the properties referred to below are predominantly determined by the concrete mix design, which is influenced and controlled by the tailor made shotcrete superplasticizer:

- Water reduction to improve shotcrete performance, compressive strength and durability whilst achieving an optimal workability.
- Workability (low viscosity/softness) for improved filling degree of the pistons of the pump, thus, achieving less pulsation and a homogenous mixing of the concrete with the shotcrete accelerator at the nozzle.
- Introducing air voids, which loosen the base mix with low w/c-ratio for an improved pumping and a more homogenous mixing at the nozzle.
- Workability time of the shotcrete base mix according to the specific site needs.
- The chemical modes of action of high range water reducers, shotcrete accelerators and any other concrete admixtures used in shotcrete must be optimally compatible to each other.

Table 4.4: Types of plasticizer/superplasticizer

	Chemical Base	Water Reduction Potential	Effect
WR	Carbohydrate / Lignin sulfonate	5 - 12 %	Electro static forces: 
HRWR	Naphthalene (SNF) and Melamine (SMF)	5 - 25 %	Electrostatic and steric repulsion: 
	Polycarboxylate (PCE)	12 - 40 %	

The most recent superplasticizers for shotcrete, achieving all these targets, are based on the latest polycarboxylate ethers (PCE). The major characteristic of the PCE based superplasticizer technology is their capability for effectively tailor-made polymer designs to achieve specific shotcrete properties.



#### 4.5.2 SETTING RETARDER / CONSISTENCY STABILIZER

The majority of sprayed concrete is used in tunneling and mining, where major logistical challenges also exist and therefore the workability times of the concrete must be as flexible as possible. This is achieved in sprayed concrete very effectively because the initial setting and strength development can be individually controlled with the help of set retarding admixtures in the base mix, on the one hand, and by the shotcrete accelerator added independently at the nozzle on the other. As a result, the workability can be extended over many hours and then the other logistical operations such as the concrete production, transport, waiting times, installation process and work breaks etc., can also be adequately planned and controlled.

SikaTard® set retarders are dedicated to be used in shotcrete. They enable almost any fresh concrete workability times to be achieved from three hours to beyond 24 hours, just by changing the dosage in the range of ca. 0.1 % to 1.0 % by wt. of cement. Naturally, the specific time effects are also strongly dependent on the other key parameters, e.g. the concrete batching, the cement/binder type, and the temperature conditions.

Irrespective of the workability time set by using SikaTard®, its effect is immediately compensated during the shotcrete processing by the usual shotcrete accelerators (Sika® Sigunit®). The cement of the shotcrete then behaves largely like the originally not delayed cement.

Table 4.5: Example of an extension of the workability time by additional addition of SikaTard®-930 (must be determined for each individual case).

Approximate Workability Time	Typical Admixture Dosage by bwc	
	Sika® ViscoCrete®-SC	SikaTard®
3 hours	0.8 - 1.3 % depending on w/c-ratio	
4 hours	0.8 - 1.3 %	0.2 - 0.4 %
8 hours	0.8 - 1.3 %	0.4 - 0.6 %
12 hours	0.8 - 1.3 %	0.6 - 0.8 %
24 hours	0.8 - 1.3 %	0.9 - 1.3 %

#### 4.5.3 SETTING AND HARDENING ACCELERATOR FOR SHOTCRETE

##### Alkali-free Accelerators

Today, liquid alkali-free accelerators have become the standard for highly demanding shotcrete applications, worldwide, due to their advantages in application and for the environment, health and safety (EHS). These products, which are based on aqueous solutions or suspensions of aluminum sulphate compounds, are safe and easy to handle, especially with respect to constant dosing, plus a very good development of early strength with optimal shotcreting characteristics and properties.

For the term "alkali-free", a distinction must be made between two chemical aspects and their respective influence on the properties of shotcrete:

- Alkalinity as a synonym for basicity

Aqueous solutions are alkaline if their pH value is higher than pH 7. Highly alkaline materials affect the health and safety of people on site during their use, because human tissue is much more sensitive and at risk from liquids with a highly alkaline pH than for example from weak acids. The traditional so-called alkaline accelerators for shotcrete, based on silicates and aluminates, exhibit an extremely high pH of 11 or beyond. The pH value of modern alkali-free accelerators, on the other hand, is in the range of weak acids and similar to that of soft drinks like fruit juices or drinks that are typically of pH value 2.5 - 3.5.

- Alkalinity as a measure of the alkali ion content

The content of alkali ions, e.g. sodium and potassium, strongly affects concrete properties. With increasing alkali content, the final compressive strength of shotcrete is reduced as well as is its long-term durability. The total alkali ion content of alkali-free accelerators, expressed as the Na<sub>2</sub>O equivalent, has to be less than 1.0 % (e.g. EN 934-5).

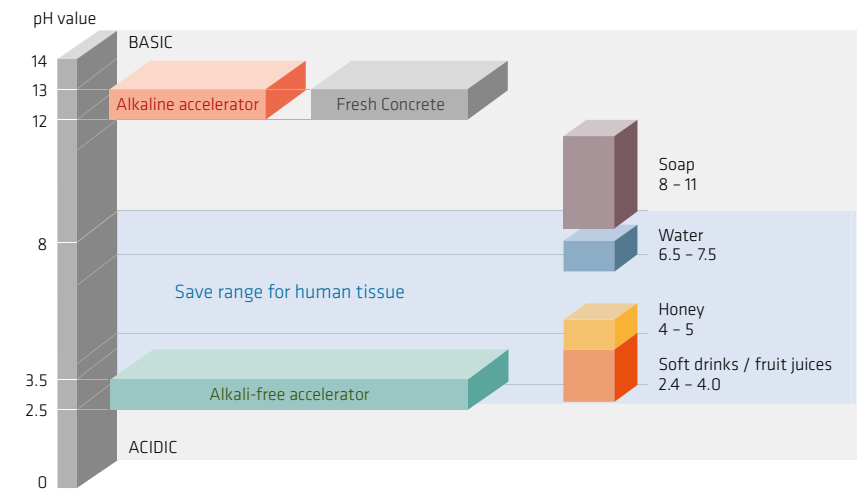

Fig. 4.2: pH range of shotcrete accelerators

Alkali-free shotcrete accelerators, in contrast to the alkaline accelerators discussed below, provide improved health and safety with more security in many areas:

- Safe Working:

Due to the AF-accelerators weak acidity of ca. pH 3, no caustic water spray mist and aerosols occur in the tunnel environment and, therefore, there is no caustic damage to people's skin, respiratory system, and eyes. Alkali-free shotcrete accelerators are non-hazardous during transport, storage, handling, or dosing.

- **Safe Environment:**  
With the use of alkali-free accelerators, there is no danger of highly alkaline materials or waste being discharged into the ground or drainage water.
- **Improved Shotcrete Quality and Durability:**  
The use of alkali-free shotcrete accelerators has almost no adverse effect on the compressive strength of the sprayed concrete.  
Almost no additional soluble alkali ions are introduced into the concrete. This greatly reduces the risk of shotcrete leaching and consequent blockages in the drainage systems.

### Chemistry in alkali-free accelerated shotcrete

Whereas for the fresh concrete a very good workability is required, i.e. for flow and pumpability, the properties of the freshly applied sprayed concrete are totally the inverted of this. An immediate strength has to be achieved which enables vertical and overhead application of reasonably thick shotcrete layers that are strong enough to bear their own weight.

Any retardation of the cement hydration might lead to a delayed collapse of the shotcrete shell due to secondary effects, e.g. creeping or water infiltration.

The early performance of alkali-free accelerated shotcrete can essentially be traced back to two, mostly successive chemical processes:

#### 1. Acceleration reaction up to ca. 2 hours from spraying

Immediately starting with the accelerator being mixed into the concrete at the nozzle, there is a very pronounced formation of ettringite. This ettringite precipitation creates a solid matrix, which is strong enough to enable safe shotcrete application overhead.

However, for chemical and technical reasons the compressive strength resulting from this primary shotcrete reaction does not usually exceed ca. 1.5 MPa. In view of potentially detrimental factors on the young shotcrete, e.g. static load forces (overhead application) or water ingress, this initial strength gain has to be followed by a subsequent hardening process because of the contribution of early onset silicate hydration as a secondary shotcrete reaction.

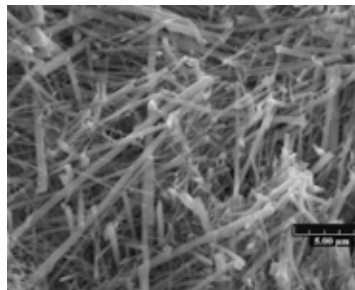

#### 2. Cement hydration reaction.

As in ordinary concrete, cement hydration contributes to the strength development of the young shotcrete, which in particular can be observed from ca. two to three hours after spraying. Any stabilization/retardation of the base mix that was achieved with the help of other admixtures e.g. the superplasticizers and retarders etc., is deactivated upon the addition of the alkali-free shotcrete accelerator. The ongoing cement hydration in shotcrete (2 - 24 hours) is essentially then unaffected by any admixtures which had been added on batching.

The start of the cement hydration reaction (cement setting) is actually also thereby moved to earlier times compared to the original base mix (without the alkali-free accelerator)

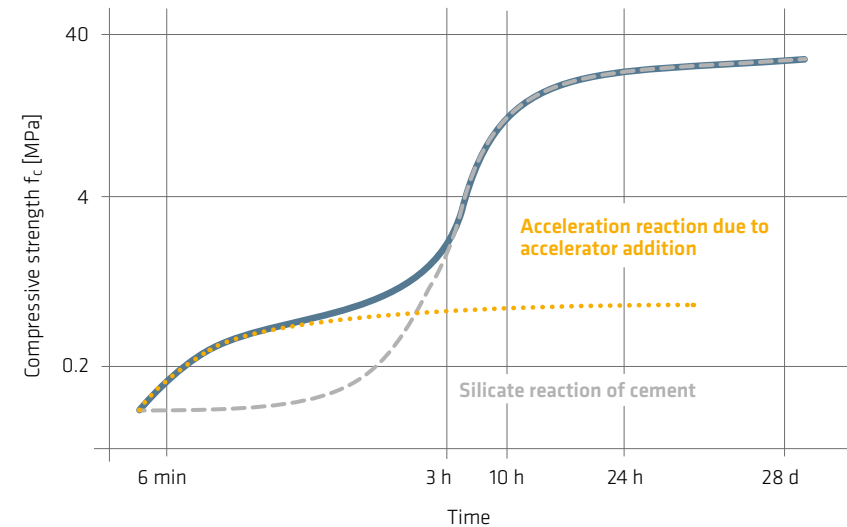

Fig. 4.3: Compressive strength development of young shotcrete and its chemical causes

Regarding the shotcrete acceleration and the early strength development, two issues have to be considered carefully – which is unfortunately not always the case:

- **The kinetics of acceleration and cement hydration**  
Apart from the acceleration reaction, the cement hydration reaction plays an important role in the early strength development of shotcrete. Like any chemical reaction, both strongly depend on the temperature of the concrete and the ambient. As a rule of thumb, the kinetics of chemical reactions, as a measure of their “speed”, changes by a factor of two to three with a temperature change of 10°C. Accordingly, a shotcrete base mix temperature of 10°C instead of the recommended 20°C has a dramatically adverse impact on the shotcrete performance.
- **The water content of a shotcrete mix**  
Not only the early shotcrete performance, but also its final quality/durability is strongly affected by the water content of the base mix, characterized by the w/c- or w/b-ratio. Water is required for the plastic properties of the fresh shotcrete and the hydration of the cement. However, any excess of water in the mix design, beyond that required for the cement hydration, reduces the initial and early strength evolution as well as the final compressive strength and density of the shotcrete.

NOTE: When evaluating low-performance shotcrete, the water content of the base mix should be given highest priority. Only a meaningful measurement of this water content of the base mix can give a realistic idea of the actual w/c-ratio.



## CHANGE OF W/C-RATIO DUE TO ACCELERATOR ADDITION

Among the additives, the usual accelerator dosages are by far the largest quantity. Therefore, it is often discussed that the additional water from the accelerator addition at the nozzle would need to be considered in terms of the w/c-ratio of the final sprayed concrete.

In order to assess this question correctly, one must not only consider the additional water content due to the addition of accelerator, but also the chemical reactions of the acceleration. In the course of these processes in young shotcrete the w/c-ratio as given by the mixing water changes due to chemical water consumption (see Fig. 4.4).

During the shotcrete acceleration the aluminium compounds added by the accelerator, under the specific chemical environment of the young shotcrete, yield in a strong ettringite precipitation. Ettringite, however, is a mineral which contains large quantities of water, about 46 % of its own weight. Still in a phase when shotcrete has to be considered a viscoelastic material, this water is removed from the shotcrete mix, resulting in an effective reduction of the w/c-ratio.

For alkali-free accelerators it can therefore be stated that these admixtures do not increase the effective w/c-ratio of the sprayed concrete applied, but even reduce it.

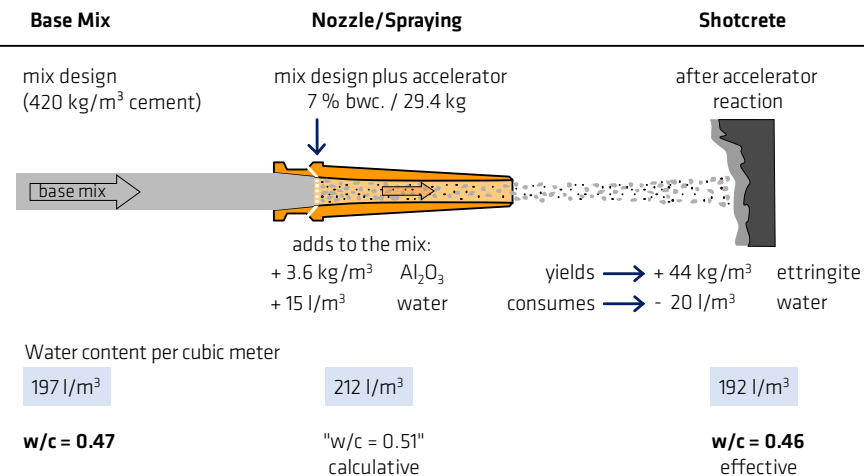

Fig. 4.4: Example of the changing w/c-ratio in the course of shotcrete application with an AF-accelerator (even neglecting the volume change).

## Alkaline Accelerators

In addition to the current state of the art alkali-free accelerator technology, outlined above, there are older types of liquid accelerators that are still used in many countries i.e. based on alkaline aqueous silicate or aluminate solutions. These are not alkali-free, contain relatively high amounts of alkali ions and are basic liquids. The chemical interactions that take place in shotcrete when using these accelerators differ markedly from those described above for the alkali-free accelerators. Even though the alkaline accelerators will usually produce very good early strength development, the final shotcrete properties become worse, e.g. the final compressive strength is substantially reduced and leaching of alkali salts, which can also then cause blockages in drainage systems, is common. Durability of the shotcrete, in general, is an issue due to the large amounts of alkali ions introduced to the mix by the accelerator, meaning the risk of alkali silicate reaction is increased.

In addition to these technical and performance differences, the use of alkaline accelerators in shotcrete also has the previously stated adverse effects regarding health and safety issues during application. Due to their high alkalinity (pH value), these products pose the risk of burns to human tissue, particularly the respiratory tract and the eyes. This applies both to direct contact (skin, eyes) and to the airborne mist of these accelerators in a tunnel environment that can be extremely harmful via normal respiration.

Table 4.6: Liquid accelerators types and their main properties

Properties	Accelerator Type		
	Alkaline Aluminate-based	Alkaline Silicate-based	Alkali-free
Dosing range	3 - 6 %	12 - 15 %	4 - 7 %
pH value	13 - 14	12 - 13	3
Na <sub>2</sub> O equivalent	20 %	12 %	<1 %
Very early strength at same dosage	++++	++++	++
Final strength	+	--	+++
Leaching behavior	---	--	-
Environment, Health and Safety	--	-	+++
	+ beneficial	- detrimental	

Table 4.7: Different types of shotcrete accelerators and their main uses

Type	Product	Use / Effect	Remarks
Liquid alkali free	Sigunit®-AFL	<ul style="list-style-type: none"> <li>■ Heading stabilization in tunneling</li> <li>■ Rock and slope stabilization</li> <li>■ High-quality lining shotcrete</li> </ul>	<ul style="list-style-type: none"> <li>■ For the dry or wet spraying process</li> <li>■ Optimal final strength</li> <li>■ Instant powders are used as ca. 55 % solutions</li> <li>■ Do not mix with alkaline accelerators</li> </ul>
Instant powder alkali free	Sigunit®-AFI	<ul style="list-style-type: none"> <li>■ High early strength</li> <li>■ Better leaching properties</li> <li>■ Better health and safety</li> </ul>	<ul style="list-style-type: none"> <li>■ Pipes and containers must be acid/corrosion resistant</li> </ul>
Powder, alkali free	Sigunit®-AF		For dry spraying process
Liquid, alkaline	Sigunit®-L	<ul style="list-style-type: none"> <li>■ Heading stabilization in tunneling</li> <li>■ Rock and slope stabilization</li> <li>■ Very high early strength</li> </ul>	<ul style="list-style-type: none"> <li>■ For the dry and wet spraying process</li> <li>■ Reduced final strength</li> <li>■ Aggressive to human tissue</li> </ul>

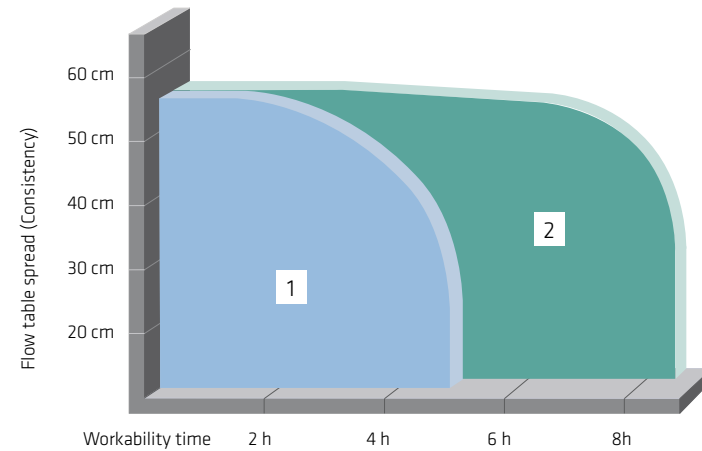

Fig. 4.5: Workability time of wet sprayed concrete mixes with a PCE-based superplasticizer Sika® ViscoCrete® SC (1) and with a combination of Sika® ViscoCrete® SC and shotcrete retarder SikaTard®-930 (2).

Table 4.8: Summary Table of Sprayed Concrete Admixtures

Type	Accelerator	Superplasticizer	Retarder / Stabilizer	Silica fume	Pumping aid	Lubrication agent	Fiber
Product	Sika® Sigunit®	Sika® ViscoCrete®	SikaTard®	SikaFume®	Sika® Stabilizer Pump	SikaPump®-Start 1	SikaFiber® Force
Effect on	Base mix	<ul style="list-style-type: none"> <li>■ High water reduction</li> <li>■ Better Workability</li> <li>■ Time-controlled workability</li> </ul>	<ul style="list-style-type: none"> <li>■ Adjustable workability time</li> </ul>	<ul style="list-style-type: none"> <li>■ Improved fresh concrete homogeneity</li> </ul>	<ul style="list-style-type: none"> <li>■ Improved homogeneity and internal cohesion of the mix</li> </ul>		
	Application	<ul style="list-style-type: none"> <li>■ Concrete placing without molds</li> <li>■ Very high initial and early strength development</li> </ul>	<ul style="list-style-type: none"> <li>■ Improved Pumpability (air entrainment)</li> <li>■ Potential of lower w/c-ratio (better strength development)</li> </ul>	<ul style="list-style-type: none"> <li>■ No cleaning of equipment during the retarding phase</li> </ul>	<ul style="list-style-type: none"> <li>■ Lower rebound</li> </ul>	<ul style="list-style-type: none"> <li>■ Increased spraying output with lower energy consumption</li> </ul>	<ul style="list-style-type: none"> <li>■ Reduces initial friction between mix and concrete lines</li> <li>■ Replaces cement slurry as pump start agent</li> </ul>
	Hardeded shotcrete		<ul style="list-style-type: none"> <li>■ Better shrinkage and creep</li> <li>■ Higher waterproofness</li> </ul>		<ul style="list-style-type: none"> <li>■ Much higher waterproofness</li> <li>■ Improved adhesion between aggregates and hardened cement</li> <li>■ High frost resistance</li> </ul>		
Remarks	Addition at the nozzle	<ul style="list-style-type: none"> <li>■ Optimal effect when added after the mixing water</li> <li>■ Dosage depends on mix design and raw materials</li> <li>■ For specific properties, preliminary tests with cement and aggregates are essential</li> </ul>		<ul style="list-style-type: none"> <li>■ Optimal curing is necessary because silica fume dries out the shotcrete surface</li> </ul>	Recommended for difficult mixes, with variable fines, low cement content, or a poor particle size distribution	Lubrication mix must not be sprayed onto shotcrete application substrate	Fibers affects workability and pumpability properties of shotcrete mixes

## 4.6 FIBERS IN SPRAYED CONCRETE

Fibers can be used as reinforcement for the concrete evenly distributed over the entire concrete cross-section. The effect of the fiber on the concrete depends on the fiber type, the material, its shape, and dimensions. Basically there are two fiber types:

- **Micro fibers** (small, fine fibers, monofilament or fibrillated,  $d < 0.30\text{mm}$ )  
The use of micro fibers can influence the properties of young shotcrete by the reduction of early age shrinkage cracks. Furthermore, the use of PP micro-fibers has an anti-spalling effect by melting and increasing void space for vapor expansion, when the concrete is exposed to elevated temperatures in the event of a fire.
- **Macro fibers** (long fibers with a larger diameter,  $> 0.30\text{mm}$ )  
Mainly used as reinforcement for the hardened concrete properties, like increase of flexural toughness, energy absorption and impact resistance.

The use of fibers in shotcrete gets more and more common as the engineers, owners, and contractors see the advantages of the use of fibers as partly or complete replacement of steel mesh reinforcement of shotcrete for temporary ground support. The benefits of fibers instead of usual reinforcement measures for ground support in tunneling and mining:

- Safer working conditions (no mounting of mesh in unsafe area)
- Faster work progress (no additional installation of the meshes)
- No spraying shadows behind meshes
- Fibers are distributed homogeneously
- Reinforcement provided by concrete producer
- No rebound due to mesh vibration

Steel fibers in shotcrete are already known for a long time and often used in tunneling or mining jobsites. There are dosing units available which can be installed at the concrete plants and there is experience in the mixing procedure for producing a workable fiber shotcrete. But steel fibers also have their disadvantages, as the large weight (handling) of the fibers, the increased wear costs of machinery due to abrasion or sharp spikes on the shotcrete surface (skin injury, damage to waterproofing membranes).

So an alternative could be polymer fibers. With polymer fibers the same energy absorption values can be reached and, depending on the fiber type, it can be an economic alternative. The benefits of polymer fibers instead of steel fibers for tunneling:

- Lower wear costs due to less abrasion of machinery
- Less weight to transport to the mixing plant
- Non-corrosive, therefore creditable as long-term reinforcement even in presence of water
- Softer polymer fibers reduce the risk of injuries for workers
- Waterproofing membranes can be placed directly over the polymer fiber reinforced shotcrete

Apart from their intended use to improve the load-bearing capacity of shotcrete, the inclusion of fibers affects the entire working cycle for shotcreting (see Table 4.8)

- **Workability and mix design:**  
Fibers reduce the workability of fresh concrete as they introduce an additional surface area that requires additional paste for lubrication (fines, binder, water). The mix design has to be adapted with respect to the paste volume when fibers are used.
- **Pumpability:**  
Generally, the passing of the fiber concrete through hopper grid and pipes limits the maximum lengths of the fibers and their dosage level. As a rule of thumb, the length of the fibers should be more than half the hose diameter, since longer fibers will orientate along the course of the hose, whereas smaller ones are able to rotate which can result in balling of the fibers and pipe blockages.



Fig. 4.6: Evenly distributed PP fibers in a broken spray test specimen.



Fig. 4.7: Steel fibers for improving energy absorption of concrete specimen.



Fig. 4.8: SikaFiber® Force-60 PP fibers automatically dosed in the production of sprayed concrete as pucks wrapped in water-soluble foil.

■ **Energy absorption:**

Concrete and shotcrete generally exhibit a brittle behavior. The deformation, which can be withstood by the concrete in compression and especially in tension is limited. In order to achieve an increased level of ductile behavior in the concrete or shotcrete, structural fibers can be added.

With the addition of fibers the brittle behavior of the material is extended to a ductile behavior, as cracks in the concrete are limited and/or bridged, with some forces taken over or transferred by the fibers. The ductility of the concrete structure is enhanced by the fiber pullout from the cracked concrete. This behavior depends on the fiber type, fiber geometry and fiber material, plus the concrete mix design and the dosage of the fibers. For example, steel fibers provide a good load-bearing capacity within a small range of deformation, whereas polymer fibers show an increasing load-bearing capacity with increasing deformation.

■ **Durability:**

The durability of the shotcrete can be improved with the use of fibers

- Micro fibers: less shrinkage cracks
- Steel fibers: good creeping behavior
- PP macro fibers: excellent chemical resistance

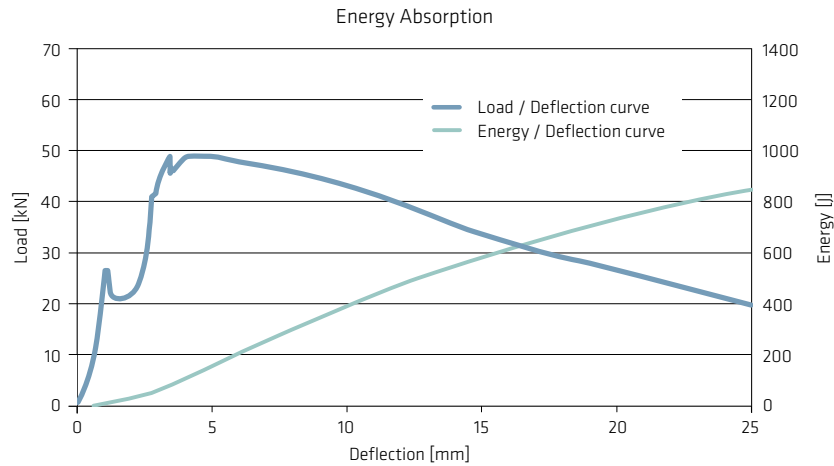

Fig. 4.9: Load deflection curve of steel fiber reinforced shotcrete (EN 14488-5)

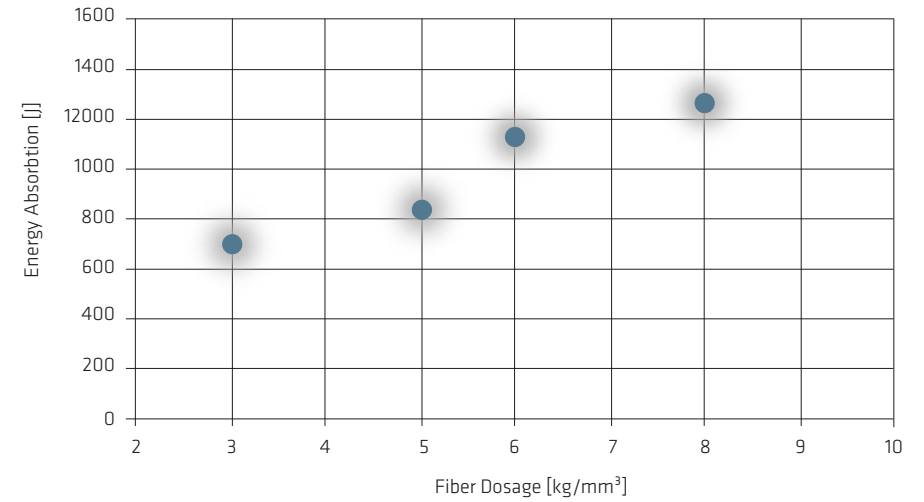

Fig. 4.10: Energy absorption in relation to SikaFiber® Force-60 dosage, measured using sprayed test panels according to EN 14488-5

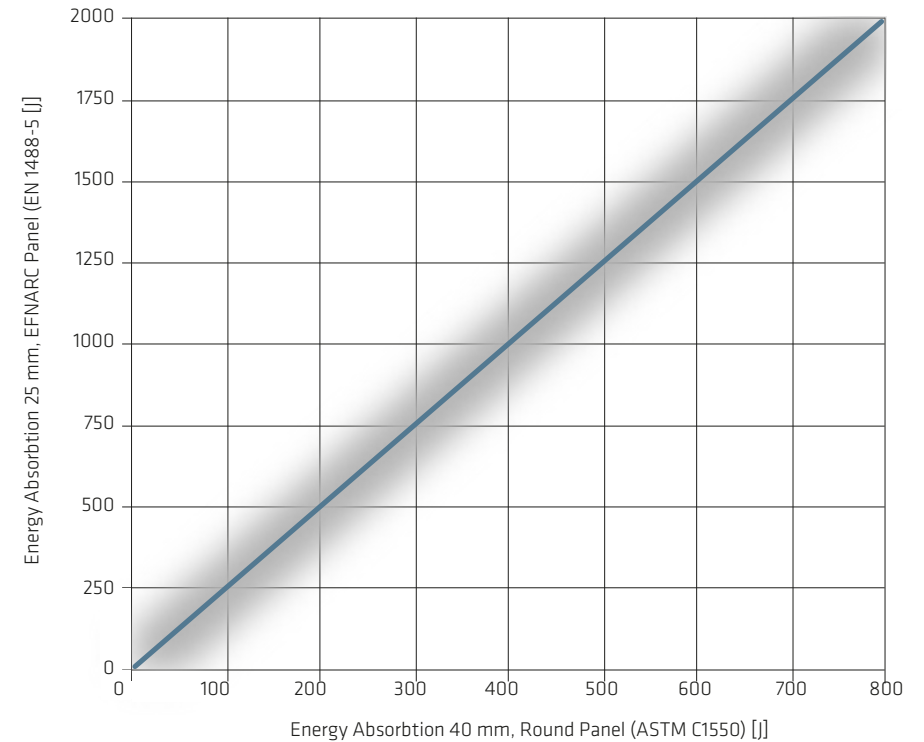

Fig. 4.11: Correlation of different test methods for the energy absorption measurement

# 5 SHOTCRETE DEFINITION BY MATERIALS

During its more than 100-year history, the classification of shotcrete has become less consistent due to additional processes and materials. Distinguishing different types of shotcrete is either done with respect to the materials or with respect to the application technology. Shotcrete classification by materials distinguishes between:

- **Dry sprayed concrete**  
The entire mix, including cement, is supplied pre-mixed and ready to use. All of the components have to be completely dry and mixed together before application. This mix is then conveyed pneumatically and the required water is added at the nozzle to produce the final dry sprayed shotcrete.
- **Earth-moist sprayed concrete**  
Similar to dry sprayed concrete but using the normal sands and aggregates available at batching plants, which is cost effective, but these generally contain variable levels of moisture. Optionally, a retarder is added to prevent the cement hydration process starting before spraying. This mix is conveyed pneumatically and the required water is added at the nozzle to produce the final earth-moist shotcrete. In case of a retarder added to the base mix, the addition of an accelerator is also required at the nozzle to neutralize the earlier retardation of the base mix.
- **Wet sprayed concrete**  
Basically, wet spraying uses a ready-mix concrete that is mixed at a batching plant. It requires a mix design with admixtures including specific superplasticizer for shotcrete and other optional admixtures like retarder, air-entrainer etc. The wet mix is pumped to the nozzle and whilst there is no specific water addition at the nozzle, there is always the addition of a liquid shotcrete accelerator, which is mandatory for wet sprayed shotcrete.

## 5.1. WET SPRAYED CONCRETE

Wet sprayed concrete means delivery (handling) of a ready-mixed concrete consisting of aggregates, cement, water and sprayed concrete admixtures in a workable, pumpable consistency. During the spray process, the wet concrete is mixed at the nozzle with air and the liquid shotcrete accelerator and then it can be applied. The wet sprayed concrete can be processed either by using the dense flow or the thin flow method. Dense flow sprayed concrete is the most recently developed process, generally used for high-performance shotcrete.

Wet sprayed concrete is used in the dense flow process, especially when large quantities of sprayed concrete have to be processed. It also offers maximum control of all parameters. This combination is by far the most popular for mechanical tunneling works because:

- working well for high output capacities
- working conditions are substantially better in the spray area, compared to dry-sprayed concrete and
- a higher durability due to a well-controlled water content.

The advantages of the wet sprayed concrete are seen in many different areas of the works. Comparing wet to dry shotcrete these advantages generally include:

- Higher nominal spraying capacity of up to 30 m<sup>3</sup>/h
- Lower rebound
- Far less dust generation
- Reduced wear costs for the equipment
- Low air requirements during spraying
- High performance and durability of the installed shotcrete (constant water content)

However, these advantages also raise limitations: wet sprayed concrete used in the dense flow process requires more work and preparations, especially initially (for start-up) and finally (for cleaning). Also the working time, until the cement starts to set, is somewhat predetermined due to the batching parameters and the sprayed concrete has to be applied within this time. After this time any non-sprayed base mix cannot be used anymore.

### 5.1.1 WET SPRAYED CONCRETE MIX DESIGN

The mix design of wet sprayed concrete depends on the specified requirements and the desired workability that means the following has to be considered:

- Mature shotcrete target specifications (compressive strength, energy absorption, durability)
- Logistics concept (delivery/handling methods/temperature conditions)
- Specified installed material conditions (very early (0 - 2h) and early (2 - 24h) strength development)
- Economics of the wet sprayed concrete mix

Based on these aspects, the cement type and content, aggregate type and grading, the w/c-ratio, as well as the type and quantity of shotcrete admixtures are selected and confirmed by tests or adjusted after trialed evaluation of the target parameters. A typical wet sprayed concrete mix design is outlined in Table 5.1, below.

With regard to aggregate particle sizes, the locally available aggregates are generally the main factor determining the best choice of grading curve. The curve that best meets the specified requirements must be determined by testing and trials with the actual available materials (see Section 5.1.1.1).

Regarding development of the mix design for wet shotcrete used in the dense flow process the most demanding task is probably achieving a good pumpability of the base mix. The pumpability essentially depends on a suitable grading curve and a sufficient volume and quality of the paste. These two critical aspects, the grading curve and the paste, are discussed more in detail, below (see Section 5.1.1.2).

#### Aggregates and Batching Water

Aggregates used in concrete production can have different effects on the dosing water, depending on the aggregate's nature and source as well as the environmental conditions. The interaction of the aggregates with the batching water results from the water content of a possible porosity of the aggregates as well as from additional water on the surface of wet aggregates. Both effects must be considered accordingly in the mix design.

Capillary porosity of aggregates leads to water adsorption effects. If the pores are water-saturated, this water must not be considered regarding calculation of the w/c-ratio. In case of partly or completely dry aggregates, however, some batching water would be immediately adsorbed by this aggregate porosity until this is saturated, the mix would stiffen, and the total batching water would have to be accordingly increased. On the other hand, the aggregates are often wet and carry additional water on their surface, which contributes to the total batching water, thus increasing the w/c-ratio.

Three extreme scenarios regarding the mix design can be defined in terms of aggregates as illustrated below. Mix design calculation is based on the SSD data, whereby the total amount of water introduced by the used aggregates (surface moisture is variable) and their absorption water have to be known and considered.



No water

#### Oven Dry (OD)

Aggregates are completely dry (outer surface and capillary pores):

- Concrete consistency will be more stiff than designed
- Concrete requires more water than calculated from the w/c-ratio until the pores are water-saturated.



Absorption water

#### Saturated Surface Dry (SSD)

Capillary pores are water-saturated and the outer surface is dry:

- Concrete consistency will be as designed
- Concrete requires batching water as calculated from the w/c-ratio.



Absorption water / Surface moisture

#### Surface Wet

Capillary pores are water-saturated and the outer surface is wet:

- Concrete consistency will be more fluid than designed
- Concrete requires less batching water than calculated from the w/c-ratio due to the additional water on the aggregate surface.

Table 5.1: Exemplary Material Space Calculation for One Cubic Meter of Wet Shotcrete

Components	Concrete Specification	Density [kg/l]	Volume per 1 m <sup>3</sup>		Weight per 1 m <sup>3</sup>		Batching per 1 m <sup>3</sup>	
			Total aggregates	Two fractions	Moisture included in mixing water	Considering moisture and solution water		
<b>Cement</b> 400 kg/m <sup>3</sup>	400 kg/m <sup>3</sup>	3.15	127 l		400 kg	400 kg		
<b>Sika® ViscoCrete® SC</b> 1 % by wt. of cem. <sup>1)</sup> (25 % solid content)	4 kg/m <sup>3</sup>	1.05	1 l		1 kg	4 kg		
<b>Total water</b> w/c = 0.48	192 kg/m <sup>3</sup>	1.0	192 l		192 kg	133 kg		
<b>Mixing water</b> total water reduced by moisture		1.0						
<b>Air</b> 4 % (planned)	4 %		40 l					
<sup>1)</sup> If the total quantity of admixtures exceeds 3 l/m <sup>3</sup> , its water content has to be considered for the w/c-ratio (EN206). Note: It is common to alternatively assign the relatively low dosed admixtures 1:1 to the batching water								
<b>Total aggregates (sand + coarse)</b>	fill to 1 m <sup>3</sup>	2.68	saturated surface dry aggregates		saturated surface dry aggregates		wet aggregates	
<b>0 - 4 mm</b> 4 % moisture		2.68	640 l		995 kg	1036 kg		
<b>4-8 mm</b> 2 % moisture		2.68	58 %	371 l	720 kg	735 kg		
			42 %	269 l	2308 kg	2308 kg		
			1000 l					

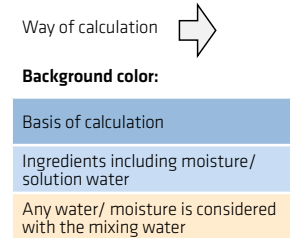

**Shotcrete Base Mix 2308 kg/m<sup>3</sup>**

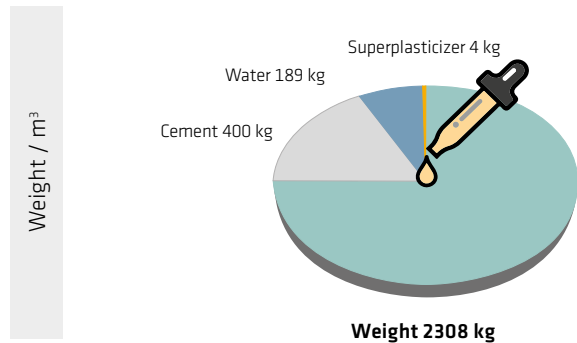
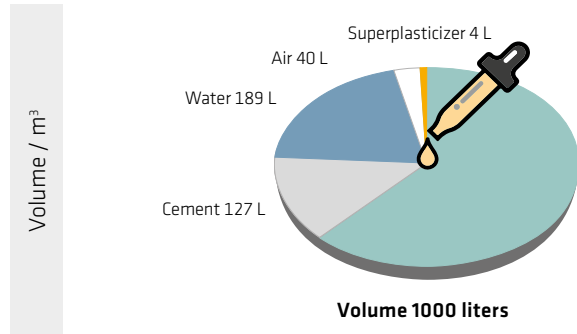

Aggregates 640 L

**SPRAYING PROCESS**

- 1) Accelerator addition  
6 % by wt. of cem.
- 2) Dust & Rebound  
Aggregates 10 %  
Cement - 4 %  
Water/ moisture - 4 %
- 3) Compaction on substrate  
- 3 % of 940 l

Approximate changes:

**Total changes (ca.)**

+ 24 kg	+ 17 l
- 172 kg	- 64 l
- 16 kg	- 5 l
- 8 kg	- 8 l
- 28 l	
<b>- 172 kg</b>	<b>- 88 l</b>

Aggregates 1715kg

**Applied Shotcrete 2343 kg/m<sup>3</sup>**

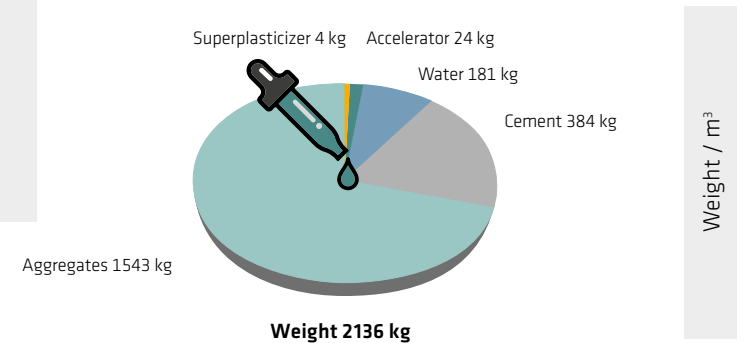
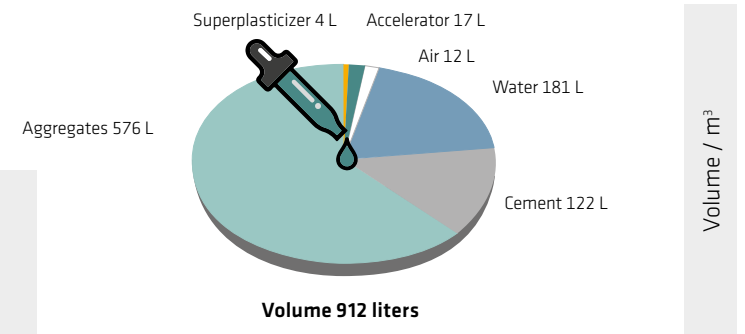

Aggregates 576 L

Aggregates 1543 kg

Fig. 5.2: Approximative material balance of wet shotcrete, before (left) and after the spraying process (right)



### 5.1.1.1 AGGREGATES GRADING

The aggregate is, by far, the largest fraction of the shotcrete. It is the most economic, space filling part of the concrete volume, which also acts as a kind of matrix of the shotcrete.

The particle size distribution of the aggregates always needs to be optimized in order to achieve:

- Maximal space filling for a high mechanical contribution to the compressive strength. A low bulk porosity also minimizes the amount of cement paste that is required for its filling.
- Minimized total surface area of the aggregates, in order to achieve a good pumpability with a minimum of paste volume.
- Well-balanced particle size distribution to ensure a stable, homogenous mix that does not separate, even under changing high pressures during pumping.

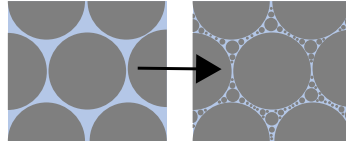

Fig. 5.3: Space filling of monodisperse particles (left) and a disperse mix (right)

The basis of all current grading curves for concrete, e.g. according to DIN 1045-2, is the so called Fuller Curve, which has been empirically developed in the early 19th century by the American engineers William B. Fuller and Sanford E. Thompson. With a grading according to the Fuller Curve it is intended to achieve an optimal packing density of particles under the practical conditions of concrete batching. However, this is dependent on the maximum grain size and the particle's shape (perfectly spherical, rounded, or crushed). The mathematical description of the Fuller curve, as originally defined by Fuller and Thompson, included all particle sizes, even of the cement, whereas the modern grading curves for concrete do not consider the cement.

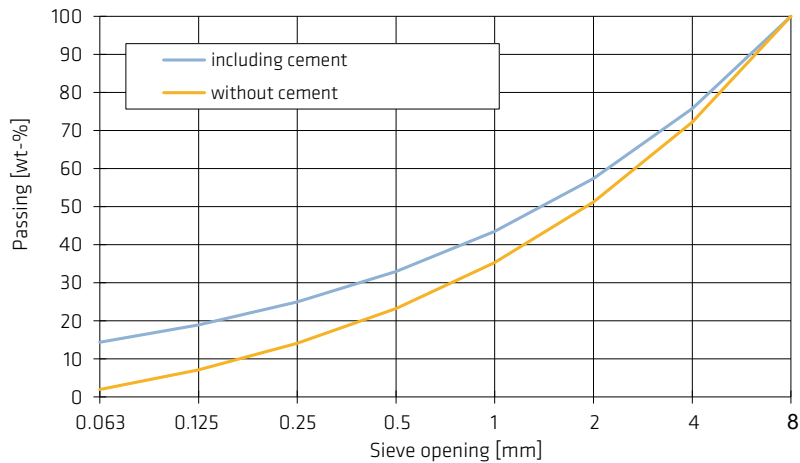

Fig. 5.4: Fuller curves for a 0-8 mm mix of natural aggregates, with and without cement

The particle shape has an effect on the demands regarding the fine fraction of the particle size distribution. Starting from an aggregate of perfect spheres, the demand for fines increases with increasing irregularity. This can be explained very well by the higher paste requirement, which is necessary to ensure lubrication of the pumping mixture.

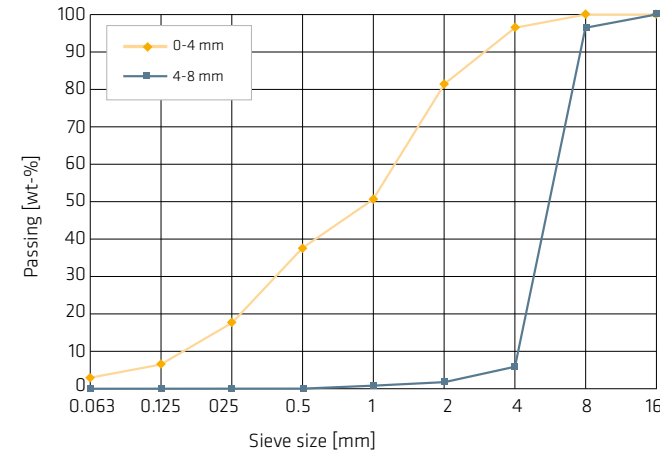

Fig. 5.5: Grading curves of the individual aggregate fractions

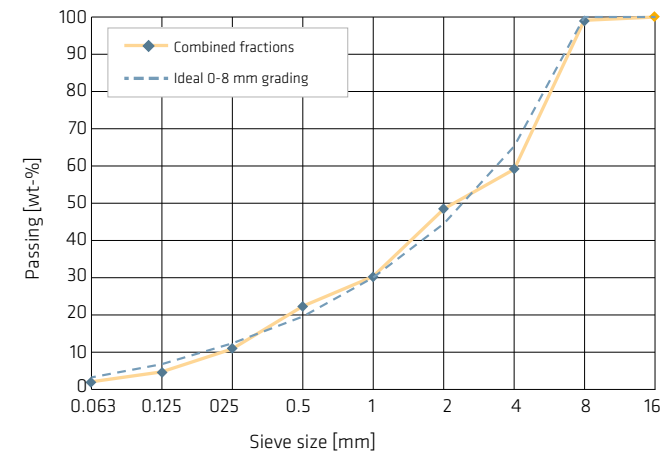

Fig. 5.6: Grading curve of the final mix design

Table 5.6: Example of a shotcrete grading curve from two sand fractions

Proportion	Fraction	Sieve opening [mm]								
		0.063 mm	0.125 mm	0.25 mm	0.5 mm	1 mm	2 mm	4 mm	8 mm	16 mm
58 %	0 - 4 mm	3 %	7 %	18 %	38 %	48 %	82 %	97 %	100 %	100 %
42 %	4 - 8 mm	0 %	0 %	0 %	0 %	1 %	2 %	6 %	97 %	100 %
	Combined fractions	2 %	4 %	11 %	22 %	30 %	48 %	59 %	99 %	100 %

In Figure 5.5 and Table 5.6 an example of a sieve curve, suitable for natural sand and aggregate is depicted. In literature there are often upper and lower limits that are given as a guideline for a suitable grading curve. However, one has always to consider the individual situation and the most important constraints regarding the grading curve which are:

- Aggregate shape -> crushed aggregates require more fines than natural gravel
- Pumpability -> rule of thumb: At least 500 kg/m<sup>3</sup> of fines are required for rounded aggregates of 0-8 mm  
-> an even, continuous grading curve is a must

Rule of thumb: For a reasonably balanced individual fraction of the aggregates, a suitable particle size distribution is typically achieved for 0-8 mm shotcrete by mixing 60 % of the sand fractions (0 - 4 mm) with 40 % of the coarse fraction (4 - 8 mm).

### 5.1.1.2 FINES AND PASTE

When wet sprayed concrete is applied by the dense flow process, the pumpability of the base mix is the most decisive factor. It has to be considered in this regard, that the pumpability is a concrete feature that is affected by various properties of the mix. In particular the pumpability is affected by the rheology of the mix (viscosity, thixotropy, shear thinning), its cohesiveness and the lubrication of the aggregates, plus the inner surfaces of the lines.

Next to the balanced sieve curve of the aggregates, all of these said properties are highly affected by the paste of the base mix: its quantity as well as its quality.

The paste comprises of all fines of the mix, plus the water and, to a certain extend, the air entrained in the mix. The fines content of a shotcrete covers any part of the mix design equal or less than a particle size of 0.125 mm, which are therefore:

- Cement
- Aggregate below 0.125 mm
- Concrete additive(s) / SCM

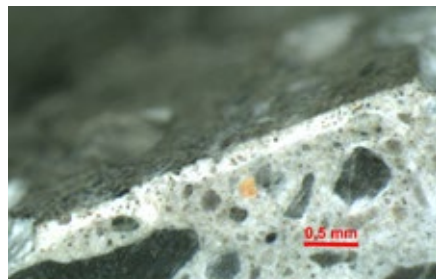

Fig. 5.7: Cutting surface of pumped shotcrete hardened in the conveying hose: the light paste layer is clearly visible on the outside

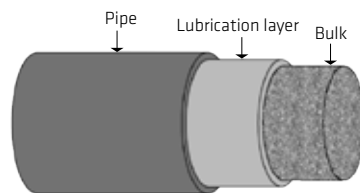

Fig. 5.8: Simplified sketch of the pumped shotcrete flow according to Kaplan et. al.<sup>9</sup>

(1) D. Kaplan, F. Larrad and T. Sedran, ACI Materials Journal, vol. 102, no. 2, pp. 110-117, 2005

The paste's impact on the pumpability covers several aspects:

- Lubrication of the lines  
In a linear pipeline, pumpability can essentially be described by the properties of a boundary layer between the pipe walls and the actual concrete mix: The concrete is regarded in this case as a static plug which moves through the pipe, shear occurs in the first approximation (at low flow rates) only at or close by this boundary layer. Here a very thin layer of the paste also acts as lubricant taking over the shear stress (Fig. 5.8). The bulk of the pumped concrete is therefore conveyed through the pipe as a plug, with a more or less thick outer shear zone, which also depends on the conveying speed.
- Internal lubrication of the aggregates in the mix  
In reality, pumped concrete, on its way from the pump to the nozzle, often has to pass reduction pipes, many turns, and bends, where the internal lubrication of the concrete becomes even more important. The concrete has to exhibit a hydraulic behavior, meaning that the aggregate particles have to move around each other easily, which is achieved by a lubricating layer of the paste.
- Cohesion of the mix  
The concrete has to withstand rather harsh conditions during pumping, esp. alternating, high pressures. The aggregates and fines must stay together, any separation of the fines would lead to coarse aggregate nests and an immediate blockage. Apart from having a uniformly even particle size distribution, the quality of the paste is important to keep the mix homogeneous.

All these aspects require a paste volume that is sufficiently higher than the volume required to fill just the space within the aggregate matrix. The rheology of a ready-mix concrete changes depending on the paste volume as well as the paste's quality, namely its water content, the type and use of plasticizers, and the mineralogy of the fines. However, there is always an individual threshold value for the paste volume, which limits the pumpability of the concrete and below which none of the afore mentioned parameters of paste quality can cause a change.

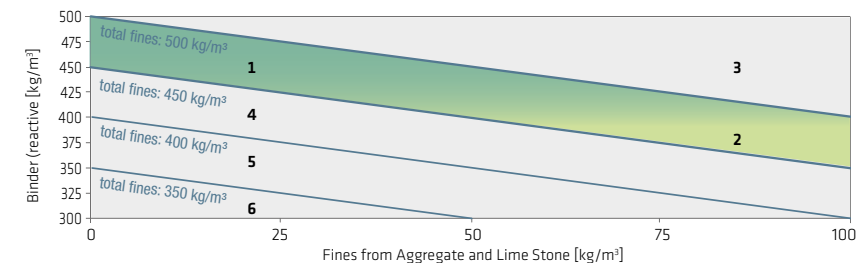

- 1 Optimal fines content: good workability, cohesion, bonding, and early strength
- 2 Similar to (1) but low cement content: risk of shotcrete performance failure (Ensure good w/c-ratio, mix design and accelerator dosage)
- 3 High fines content: tacky concrete, bad mixing of accelerator and concrete
- 4 Low fines content: low lubrication, bad workability and pumpability
- 5 Risk of sedimentation, bleeding, and blockages

Fig. 5.9: Influence of fines content on shotcrete mix design (0 - 8 mm aggregates)

In a typical 0 – 8 mm aggregate mix for shotcrete the required paste volume should be in the range of 330 l/m<sup>3</sup> to 380 l/m<sup>3</sup>. Below this range pumping problems may be expected. However, the exact paste volume required depends in particular on the shape of the aggregates. Whereas the lower limit of paste volume would work for pumping a base mix using rounded aggregates, the minimum paste demand would increase by 10 – 20 l/m<sup>3</sup> with crushed aggregates.

In order to assess a given mix design, as a rule of thumb, a pumpable shotcrete mix, exhibiting a reasonable 0 – 8 mm aggregate grading (rounded) and a w/c = 0.47 for example, should comprise a total amount of fines of about 500 kg. E.g. when the aggregates would introduce about 100 kg/m<sup>3</sup> of fines, 400 kg/m<sup>3</sup> of cement would be required to get a total of 500 kg/m<sup>3</sup> fines in the mix. This quantity would be expected to produce a stable (non-bleeding) paste volume of about 350 l/m<sup>3</sup>. This paste volume is sufficient to lubricate the aggregate particles of this mix. All interspaces of the aggregate packing are entirely filled and there's enough paste available to form a layer covering all particles and the surfaces of the equipment pipes.

Consequently a given mix design has to be well adjusted with respect to the fines that are introduced by the aggregates, the cement content, and any additional additives. The properties of the base mix are influenced by the fines content / paste volume depending on whether it is:

- *low:*  
The mix will exhibit poor pumpability due to inadequately low lubrication. As it is likely that the missing solid part of the paste is compensated by water, there is a high risk of segregation and bleeding causing blockages, and the shotcrete's 28d compressive strength will be reduced due to a lack of cementitious paste ("glue") in the space between the aggregate particles.
- *correct:*  
The mix will exhibit an optimal structure, reasonable water retention, and workability. The aggregates are well lubricated for good pumpability. The 28d compressive strength is optimal (with respect to the paste's contribution to it) since the aggregate matrix is entirely filled and interconnected by the emerging cement stone.
- *high:*  
The mix is rather tacky and difficult to spray, e.g. non-homogeneous mixing of the accelerator might appear. Since the paste is the part of the concrete that is bringing about volume changes due to the hydration processes, an excess of paste volume might cause a higher creep and shrinkage.

Apart from the paste volume, one has always to consider the paste quality. Next to the balanced grading of the aggregates, it is the paste quality which strongly affects the pumpability of the shotcrete by means of its cohesiveness: even a perfect grading curve of the aggregates cannot ensure a cohesive and well pumpable base mix, if the paste quality is inadequate, e.g. if there is:

- too much water and/or superplasticizer (low viscosity)
- an inappropriately high proportion of SCM (rheology is too sticky)

In some cases, additional air can be introduced into the mix to improve the paste quality and this also positively affects the pumpability and sprayability of a mix, however, this can never compensate for insufficient paste volume.

### 5.1.1.3 BATCHING WATER

The entire mixing water, comprising the added water and the water from aggregates moisture and from admixtures, influences the properties of the fresh base mix (plasticity) and, in combination with the chemical reactions during acceleration and cement hydration, the final shotcrete properties (e.g. durability).

The water content of the concrete is expressed as water/cement-ratio (w/c-ratio) or as water/binder-ratio (w/b-ratio). As a basic rule for the w/c-ratio, the following applies to shotcrete for securing excavations (strength class J2):

- w/c ≤ 0.50 as minimal requirement for shotcrete
- w/c ≤ 0.46 as preferred range for shotcrete

It has to be considered that the absolute water content of a mix required to achieve a certain fluidity, differs depending on the binder's composition. In comparison with cement and amongst each other, the individual behavior of additives (SCMs) with regard to water requirements differ due to their particle size and chemical properties.

Due to the chemical reactions taking place in shotcrete, part of the batching water is chemically "consumed" in the newly formed solid hydrate phases. Assuming a typical AF-accelerator dosage of 6 % by wt. of cement, the water consumption in relation to the cement mass for the different chemical processes, acceleration and cement hydration, is approximately:

- 2 % chemically bound in ettringite from the acceleration reaction
- 25 % chemically bound in cement hydrates
- 15 % physically bound to the cement hydrates (gel water)

Accordingly, any water added to the wet base mix for shotcrete which is beyond w/c = 0.42 can be taken as excess water which would subsequently lead to capillary pores in the cement matrix. The total water content of a concrete mix consists of the total batching water and part of the intrinsic moisture adsorbed in the aggregates used. As in any concrete, the amount of water in a mix greatly affects all properties of hardened shotcrete and is generally the dominant factor for its durability: the lower the w/c-ratio the better the durability of the shotcrete lining.

## Measures to improve individual properties of wet shotcrete mixes

Quantities for the individual measures are not intended to provide specific dosage instructions, but only as a guide.

Mix Design (exemplary, according to Table 5.1)		
Ingredients	Type	Value
Cement	OPC / CEM I	400 kg
Aggregates	0 - 8 mm	1771 kg
Water	According to specifications	192 kg
Superplasticizer	Sika® ViscoCrete® SC	1 %
Fines content	Cement and fines ≤ 0.125 mm	450 - 500 kg
Accelerator	Sigunit® AF	5-8 %

Recommended Shotcrete Parameters	
Flow table spread	450 - 650 mm
Temperature	20 °C
w/c-ratio	≤ 0.48
Air voids	3 - 5 %
Workability time	2-3 hrs
Shotcrete performance	J2

Higher Initial Strength		
Mix Design Change	Product	Effect
+ 2 % Accelerator	Sigunit® (alkali.free)	Higher initial strength development
+ 0.2 % Superplasticizer	Sika® ViscoCrete® SC	Water reduction, better fluidity of the mix
- 10 to 15 kg water	Water	Higher initial and early strength

Higher Final Compressive Strength		
Mix Design Change	Product	Effect
+ 20 kg Silica fume	SikaFume®	Increased density
+ 0.2 % Superplasticizer	Sika® ViscoCrete® SC	Water reduction
- 10 to 15 kg water	Water	Higher compressive strength

Longer Workability Time		
Mix Design Change	Product	Effect
+ 0.3 % Retarder	SikaTard®	Hydration retardation

Better Pumpability		
Mix Design Change	Product	Effect
+ 30 kg Fines	Fine sand / Limestone / Fly ash / Cement	Lubrication
+ 0.5 % Pumping agent	Sika® Stabilizer Pump	Decreased pump pressure
+ 0.2 % Superplasticizer	Sika® ViscoCrete® SC	Better workability

Higher Durability I		
Mix Design Change	Product	Effect
- 15 kg Water	Water	Increased density
+ 0.2 % Superplasticizer	Sika® ViscoCrete® SC	Water reduction, better workability

Higher Durability II		
Mix Design Change	Product	Effect
+ 30 kg Silica fume	SikaFume®	Increased density
+ 0.2 % Superplasticizer	Sika® ViscoCrete® SC	Water reduction, better workability

Increased Ductility I		
Mix Design Change	Product	Effect
+ 20-40 kg Macro steel fibers	SikaFiber®	Higher energy absorption
+ 0.2 % Superplasticizer	Sika® ViscoCrete® SC	Better workability

Increased Ductility II		
Mix Design Change	Product	Effect
+ 8-10 kg Macro synthetic fibers	SikaFiber® Force	Higher energy absorption
+ 0.2 % Superplasticizer	Sika® ViscoCrete® SC	Better workability

Improved Fire Resistance		
Mix Design Change	Product	Effect
+ 2 kg Micro synthetic fibers	SikaFiber®	Vapor pressure reduction
+ 0.2 % Superplasticizer	Sika® ViscoCrete® SC	Better workability

Improved Sustainability I		
Mix Design Change	Product	Effect
- 70 kg Cement	CEM I	Improved durability, reduced CO <sub>2</sub> footprint
+ 70 kg Additives	e.g. limestone / fly ash / slag	Substitution

Improved Sustainability II		
Mix Design Change	Product	Effect
- 400 kg Cement	CEM I	Improved durability, reduced CO <sub>2</sub> footprint
+ 400 kg Blended cement	CEM II or CEM III	Substitution

## 5.2. DRY SPRAYED CONCRETE

Dry sprayed concrete process with delivery (transport) of a dry, ready-mixed sprayed concrete consisting of aggregates, cement, and any sprayed concrete admixtures but without the mixing water. This ready-mixed formulation is either completely dry (oven dry) or is wetted only by the inherent moisture in the aggregates. For the spraying operation, the dry sprayed concrete is mixed at the nozzle with water and shotcrete accelerator and then immediately applied. Instead of shotcrete accelerators, special rapid-hardening cements that set in a very short time after wetting with water can also be used as an alternative in the dry spray process. The thin flow process must be used for the delivery of dry sprayed concrete. Dry sprayed concrete was the first one developed and is a process that has long proved successful and has been continuously developed and improved.

Dry sprayed concrete is used when smaller quantities and outputs are required, and when high very early strength is essential, for example for preliminary sealing against high water penetration with gunites. Typical applications for dry sprayed concrete and ready-mixed gunites are:

- Concrete repair works
- Preliminary surface sealing against water ingress or leakage
- Smaller to medium sized sprayed concrete works
- Waterproofing works
- When the logistics concept is not time dependent (with available local storage)

The advantages of dry sprayed concrete lie in its flexibility:

- High very early strength for preliminary surface sealing or stabilizing
- Almost unlimited shelf life (local availability) of silo stored material
- No premixed concrete left over as waste

With dry sprayed concrete, however, the economics are strongly affected by the high rebound quantities and dust generation and the higher equipment wear costs.

### 5.2.1 DRY SPRAYED CONCRETE MIX DESIGN

The mix design of dry sprayed concrete again depends on the specific requirements. However, apart from the early strength requirements, adaptation to minimize dust generation and rebound quantities is essential for the economic use of dry sprayed concrete. It is as a result of these parameters that the cement type and content, aggregate type and grading, water content (inherent moisture), and the type and quantity of sprayed concrete admixtures are selected.

In respect of the aggregate grading, the aggregates available locally are again the main factor determining the choice of grading curve. The curve that best meets the specified requirements must be established by testing and trials experience with the granular material available. In dry sprayed concrete, often oven-dried ready mixes are used, which are supplied in bags, big bags, or by silo and therefore they have to be stored locally before use. In this way and where there is suitable space available locally, the site is also not dependent on the aggregate obtainable locally.

Dry shotcrete mixes based on oven dried materials are highly specialized, factory prebatched products, which might also make use of special cement types that could not be used for shotcrete from wet or earth-moist mixes, because the presence of moisture would result in blockages (clogging) in the pneumatic dry delivery system, or even destroy the product's potential application characteristics and performance properties, due to pre-hydration of the cement before its use.

### 5.2.2 EARTH-MOIST SHOTCRETE

Apart from the oven dry products, earth-moist shotcrete mixes can often be a technically and economically interesting material for thin flow, dry spray application. All of the bulk ingredients are standard products available from ordinary batching plants. The inherent moisture content of the aggregates should be between 2 % and 5 % and this is either controlled by the normal moisture in the granular material or obtained additionally by means of special wetting installations. The moisture content is very important for controlled dust generation and efficient delivery. This earth moist shotcrete mixes produced locally at a batching plant always have some inherent moisture, because the aggregates can only be kept dry with a great deal of effort and expensively adapted facilities. Therefore, preferably a retarding admixture is added during batching to prevent early pre-hydration of the cement. Consequently, when spraying earth-moist mixes an accelerator should be added, to compensate the retarding effect on the one hand and to achieve the required shotcrete stiffening and hardening on the other hand.

# 6 SHOTCRETE DEFINITION BY PROCESS

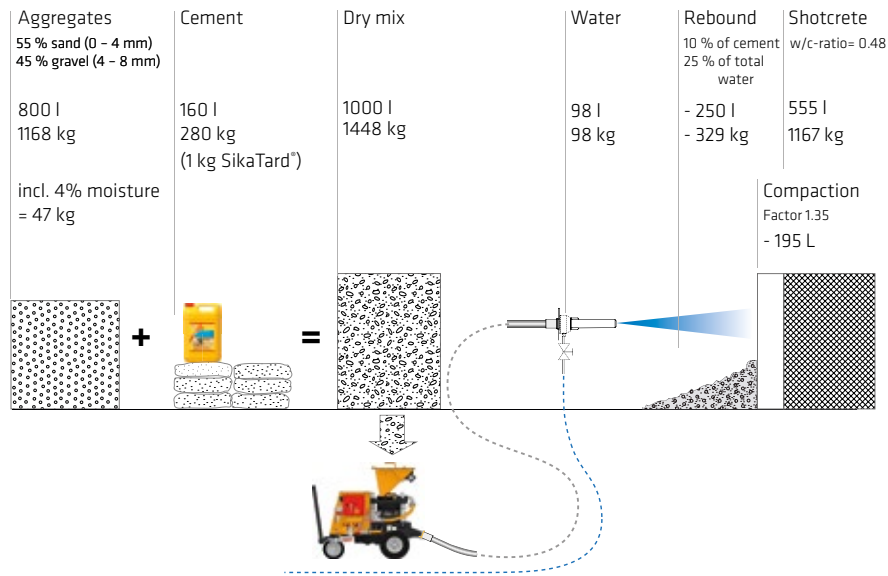

Fig. 5.10: Approximate material balance of a dry shotcrete with an assumed w/c-ratio of 0.46  
 Note: The bulk volume of the dry concrete mix is higher than that of the aggregates, as a cement layer is adhered to the earth-moist particles.

$$\text{Cement content in the applied shotcrete} = \frac{\text{cement amount} - \text{cement loss}^{\text{①}}}{\text{volume of applied shotcrete}}$$

$$\frac{0.9 \times 280 \text{ kg/m}^3 \times 1000 \text{ L}}{555 \text{ L}} = 454 \text{ kg/m}^3$$

<sup>①</sup> 25 % rebound ± 10 % cement

Fig. 5.11: Cement content in applied dry shotcrete

The spraying process is defined by the conveyance of the sprayed concrete or mortar from the delivery vehicle up to the nozzle and by the spraying of the material. There are two basic systems used for shotcrete:

- **Dense flow process**  
 The base mix is conveyed to the nozzle by pumping. Therefore, only a pumpable, ready-mixed concrete (wet sprayed concrete) is suitable for use in dense flow spray process. At the nozzle the base mix is mixed with the accelerator with the help of compressed air which also then disperses, projects and compacts the shotcrete onto the substrate.
- **Thin flow process**  
 The base mix is conveyed pneumatically to the nozzle where it is mixed with water and, depending on the shotcrete type, sometimes with a shotcrete accelerator. The most recently developed types of equipment used for this shotcrete technology are rotor machines and pressure silo units, which allow a very constant flow of the shotcrete. This shotcrete equipment technology, can also be used for any other type of shotcrete, even wet shotcrete (e.g. by using an appropriate Aliva rotor machine).

Table 6.1: Dense- and thin flow process with different shotcrete materials



Process	Conveyor principle	Equipment	Shotcrete material	Additions at the nozzle
Thin flow	Pneumatic (air) 	Rotor machine	Gunite, oven-dry (bagged)	Water
			Dry mix, earth-moist	Water + Accelerator
			Wet-mix shotcrete	Air + Accelerator
Dense flow	Hydraulic 	Piston pump	Wet-mix shotcrete	Air + Accelerator

Table 6.2: Application fields of the various processes

	Thin flow			Dense flow
	Equipment / Material	Rotor / ready-mix Mortar	Rotor / earth-moist Concrete	Rotor / concrete
<b>Requirements on Delivery</b>				
Delivery distance > 200 m	x			x <sup>(1)</sup>
Delivery distance 40 - 200 m	x	x		x <sup>(1)</sup>
Delivery distance < 40 m	x	x	x	x
Delivery output > 10 m³/h			x	x
Delivery output 3 - 10 m³/h	x	x	x	x
Delivery output < 3 m³/h	x	x		
Delivery height > 100 m	x			x <sup>(1)</sup>
Delivery height 20 - 100 m	x	x		x <sup>(1)</sup>
Delivery height < 20 m	x	x	x	x
<b>Conditions at Site</b>				
Less space / narrow	x	x	x	
Operations with many interruptions	x	x	x <sup>(2)</sup>	x <sup>(2)</sup>
Need of extremely high strength performance (water inleakage / low temperature / ...)	x			
<b>Kind of Application</b>				
Tunneling and big mines				x
Slope stabilization			x	x
Trench stabilization		x	x	x
Refurbishment	x	x		
Art building	x	x		
Sealing	x			

x = suitable

<sup>(1)</sup> = high amount of waste

<sup>(2)</sup> = retarded concrete

## 6.1 DENSE FLOW PROCESS

When substantially high quantities of shotcrete are to be applied, e.g. for the excavation stabilization in tunneling and mining, the dense flow process is generally the first choice. The dense flow process consists of three steps:

- Truck delivery of a base mix (ready-mix concrete)
- Conveying the dense concrete through the spray arm's piping to the nozzle (concrete pump)
- Spraying the concrete with compressed air and the addition of an accelerator (nozzle with converter ring and spray tip)

The base mix for this process, is basically a ready-mix concrete that is pumped through pipelines in a dense flow to the nozzle. The dense flow of concrete is torn open at the converter ring of the nozzle by compressed air, mixed at the same time with the accelerator, and immediately projected onto the substrate. The nozzle tip shapes the thin-stream of concrete-accelerator mixture to a uniform spray jet.

Apart from the spraying equipment and the accelerator addition at the nozzle, the main difference between dense flow shotcrete and conventional pumped concrete, lies in the requirement for the flow pulsation to be as low and consistent as possible during conveyance of the material, in order to obtain a homogenous shotcrete layer. To achieve this, various measures are taken to improve the feed rate and reduce interruptions.

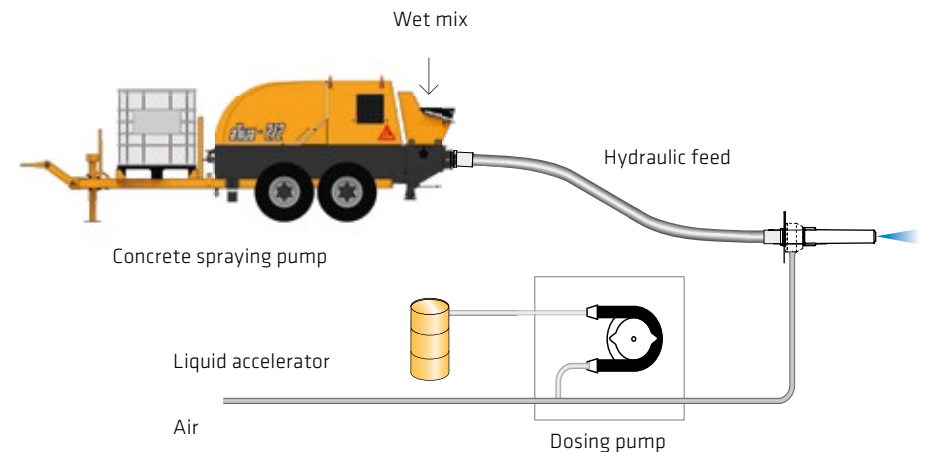

Fig. 6.1: Dense flow process for wet sprayed concrete



### 6.1.1 ADVANTAGES

Dense flow spraying is the most modern and efficient method of installing sprayed concrete when compared to thin flow spraying, with advantages including:

- Higher spray output capacity, up to ca. 30 m<sup>3</sup>/h
- Reduced wear costs on the spray equipment
- Much lower compressed air volume requirement
- Optimum quality control of the sprayed concrete

This application process, however, is limited to only being used for wet-mix shotcrete, with its high demands regarding the shotcrete mix design and pumpability.

### 6.1.2 EQUIPMENT FOR THE DENSE FLOW PROCESS

Manual as well as mechanical application methods can be used for the wet spray process, but wet sprayed concrete is more preferably applied by machine. The high spray outputs and large cross sections in many tunnels also require the work to be mechanized.

Concrete dense flow spray equipment systems mainly use double piston pumps for wet shotcrete mixes. Unlike conventional concrete pumps, the pumps used for shotcrete have to meet the additional requirement of delivering a concrete flow that is as constant as possible, to ensure homogeneous spray application. These spray systems are available in different sizes, from smaller pumps with compressed air units that are combined with separate accelerator dosing and nozzle systems, to much larger complete spraying systems with integral pump, accelerator dosing, compressed air supply and a robotic spray arm with the nozzle. The operator controls the entire spray process from a safe location by remote control.

#### Functional principle of a double piston pump

Double-piston shotcrete pumps are operated hydraulically and powered by electric or diesel engines. They consist of the hopper into which the delivered concrete mix is filled, the double piston pump is connected to it and an S-valve through which the concrete is pumped alternately from both cylinders into the delivery line.

The two pistons are hydraulically connected and operate in a push-pull arrangement.

The backward piston generates a negative pressure and is filled with concrete from the hopper. At the same time, the forward piston presses the concrete into the delivery pipe via the S-valve. At the end of each stroke, the two pistons are reversed, the S-valve swivels from the last pumping cylinder to the previously filled, now the ejecting cylinder and this concrete now reaches the delivery line.

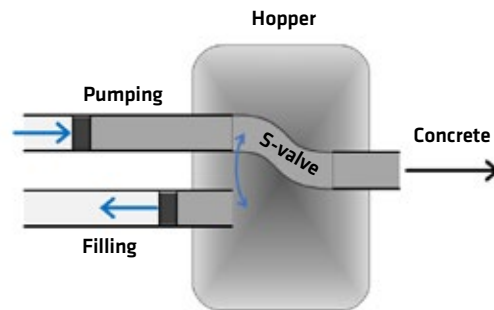

Fig. 6.2: Function principle of double piston pump



Fig. 6.3: Trailer based pumping system Aliva®-272 with a double piston pump



Fig. 6.4: Aliva® Quick Connect spray head is compatible with any standard quick release system



Fig. 6.5: Aliva®-503.3 Mini shotcrete spraying system



Fig. 6.6: Aliva®-520 Shotcrete spraying system

## 6.2 THIN FLOW PROCESS

In case of smaller shotcrete applications, i.e. where high flexibility in the installation, materials and/or working schedule is required, the thin flow process is preferred. Nowadays, this process is mainly performed using rotor machines.

The thin flow process consists of three steps:

- Delivery of a base mix (dry, earth-moist, wet)
- Conveying the base mix pneumatically, in a thin flow, through the pipes to the nozzle (via a rotor machine)
- Spraying the concrete with water added at, or a few meters ahead of the nozzle (dry, earth-moist) or the addition of an accelerator (wet)

Since the shotcrete mix is conveyed pneumatically (in a thin flow), the shotcrete needs no further dispersion at the nozzle. Spray machines for the thin flow process are considerably smaller than those for dense flow processing, therefore, this technique is ideally suited for many applications in refurbishment works, especially those where space and spatial limitations could impede the work.

If required, a shotcrete accelerator is fed by a metering unit through separate hoses to the nozzle. In the case of oven dry mixes, however, accelerators can be replaced by using special rapid cements that set in a very short time after their wetting with water.

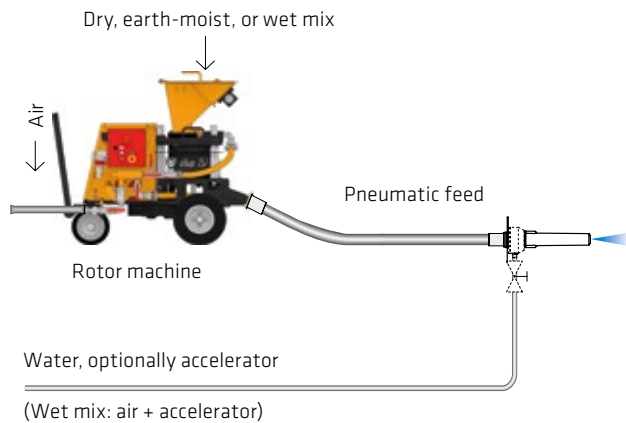

Fig. 6.7: Thin flow process for dry and wet shotcrete

### 6.2.1 ADVANTAGES

Thin flow spraying is the traditional method of applying sprayed concrete and well known throughout the world. Its advantages lie in its flexibility regarding application and performance:

- Simple handling and easy cleaning of the equipment
- High very early strength for preliminary sealing or stabilizing (special gunites)
- Almost unlimited holding time (availability) of dry silo material
- No concrete waste
- Can be used for wet-mix shotcrete

With dry sprayed concrete, the economics are affected by the rebound quantities and dust generation and the higher wear costs. The ideal applications for the thin flow process using dry mixes and ready-mixed dry shotcrete are:

- Concrete repairs
- Preliminary sealing in high water penetration
- Small to medium spraying works
- Logistics concept not time dependent (site storage)

The thin flow process for wet-mix shotcrete is preferably used in small wet-mix applications and is beneficial due to its lower requirements regarding fines and paste volume since it does not need the line lubrication as it is the case for dense flow. Accordingly, the mix design requirements in view of pumpability are less demanding.

### 6.2.2 EQUIPMENT FOR THE THIN FLOW PROCESS

Both manual and mechanical spraying systems are used for the dry process. Since dry sprayed concrete is very often used for projects with lower spray outputs, manual application by a trained nozzleman is far more important than for the dense flow process. As previously outlined, dry mixes are generally applied by rotor machines, which may differ by:

- Spray output (m<sup>3</sup>/h)
- Uses (dry / earth-moist / wet)
- Drive power (pneumatic / electric)
- Size of spray unit (dimensions / weight)
- Control (manual/partially automated)
- Operation (on the unit / by remote control)
- Additional installations required (metering units/cleaning equipment)

Rotor machines are robust in design and have a long tradition of successful use, but there is still scope for development, probably concentrating on the following areas:

- Increasing the resistance of wearing parts
- Improving the dust protection
- More efficient chamber filling
- Increasing the spray output for some markets

### Functional Description of Aliva® Rotor Machines

The conveyor material in the filling hopper (7) slides into the rotor chamber (6). By rotating the rotor (2) and the connected top air (1) the conveyor material is conveyed into the blow-off chamber (5). With the support of the bottom air (3) the conveyor material reaches the conveyor line (4). It is conveyed from there in a thin stream to the spray nozzle, where the required additive is mixed in.

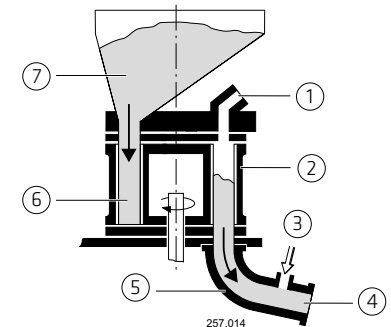

Fig. 6.8: Operating principle of the rotor-type machine



Fig. 6.9: Aliva®-257 machine

# 7 SPRAYED CONCRETE APPLICATION

## 7.1 HEALTH AND SAFETY

Health and Safety is a central issue throughout the construction industry, but this is particularly important in sprayed concrete application, because this combines potentially hazardous components and high-powered machinery with a method of application in which the concrete is projected through the air and applied overhead. Finally, there is the freshly applied shotcrete itself, which is a serious safety issue by its nature and the area of application.

Shotcrete is probably one of the most sophisticated applications and uses of concrete. Its users and people in the immediate vicinity must be protected.

Apart from the outline information below, all relevant and more specific local regulations regarding EHS must be followed and fully considered as required for the materials, equipment, and application processes.

### 7.1.1 ENVIRONMENT, HEALTH, SAFETY (EHS) FOR CEMENT

A key component of shotcrete is the cement. Cement is an extremely fine inorganic powder that mainly contains oxidic compounds of aluminum and silicon. Due to its composition, cement brings several dangers:

- As a dusty inorganic powder there is the high risk of pneumoconiosis (silicosis) for people who work with the dry material.
- In addition, due to the cement's high affinity to moisture, whenever dry cement gets in contact with the skin it reacts highly alkaline and is strongly caustic to human tissue. Strong, delayed irritation/eczema may also result (cement burns).
- Portland cements always comprise chromate (Cr IV), which can lead to an allergic reaction through regular skin contact. This danger is reduced by the added chromate reducers, but is never completely excluded.

Accordingly, when working with cement or cementitious materials, the minimum personal protective equipment (PPE) should include effective skin, eye, and respiratory protection.

### 7.1.2 EHS FOR THE BASE MIX

For fresh concrete, apart from the potential dust problems, the same health and safety problems apply as for cement: especially for the high alkalinity of the cement paste (high pH > 12), but also the potential chromate issue should be considered when working with fresh concrete.

Effective skin, eye, and respiratory protection are the minimal personal protective equipment.

### 7.1.3 EHS FOR SHOTCRETE ADMIXTURES

Usually, EHS issues with respect to the admixtures are only relevant during the base mix production. At the batching plant, the detailed instructions on the material safety data sheets (SDS) for each admixture must be followed.

For shotcrete, in contrast to ordinary concrete, there is a difference, in that there is also the accelerator as an important admixture, which has to be handled and added on site. All of the people involved in shotcrete works must be made aware of the accelerator used and its specific EHS aspects such as:

- Causticity, especially for alkaline products (requiring eye, skin, and respiratory protection)
- Corrosion of ordinary steel by alkali-free products (requires stainless steel or plastic storage tanks and equipment component parts)
- Procedures for dealing with any leaks or spillages etc.

The individual product's material safety data sheet must be carefully considered. In general terms, all usual personal protection equipment for chemicals handling and use must be used.

### 7.1.4 APPLICATION WITH HEAVY EQUIPMENT

When dealing with shotcrete in underground construction there is the key issue of the confined space with poor lighting and ventilation. Consequently, throughout the entire shotcrete process working chain, suitable precautions must be considered, for which all of the people involved must be appropriately trained and made aware of, including:

- Transportation of the base mix in large vehicles on site and especially below ground requires walking carefully and looking forwards, wearing high-visibility protective clothing, adequate lighting on the vehicle (and keeping it clean), and a reversing alarm signal.
- Transfer of the base mix to the conveyor with full personal safety equipment (PPE, with splash protection for eyes being particularly important)
- Conveyance under high pressure of concrete, air, and shotcrete accelerator to the point of spray application: Maintenance of the equipment according to the manufacturer's guidelines (regularly checking the conveyor tubes and hoses), using appropriate employee technical training, personal safety equipment, and ensuring the provision of adequate site lighting and ventilation.

- Application of the sprayed concrete: Personal safety equipment (impact-resistant goggles, helmet, gloves, breathing apparatus, ear defenders, safety boots, full body clothing), no entry to unprotected, freshly sprayed areas, adequate lighting and ventilation.
- Persons who are not specifically involved in the spraying process must not be in the vicinity of the spraying operations. It is only the nozzle man who is allowed to remain there.

### 7.1.5 SHOTCRETE FOR EXCAVATION STABILIZATION

The most serious hazards during shotcrete applications to stabilize excavated areas are without doubt the risk of fresh sprayed concrete or unstable substrate falling onto people. A meaningful plan and comprehensive organization of the works is essential for these issues:

- All of the people working in the shotcrete sector must be well trained and have a sound knowledge of the technology.
- Only the nozzleman / equipment operator is allowed to stay in the working area.
- The compressive strength development of the young shotcrete (e.g. J2 shotcrete) must be ensured by frequent, regular quality control testing of both the fresh concrete and the young shotcrete, for up to 24 hours, according to the performance requirements.
- Nobody ever works under young shotcrete or stays there, especially not in the time period of one hour from spraying.

## 7.2 SUBSTRATES

The bond between the sprayed concrete and the substrate can only be as good as the quality of the two contact faces. Due to its binder content and high jet impact speed, the sprayed concrete has the right conditions for a strong interlocking bond with the substrate and so can develop high adhesive strength. Therefore, the other face of contact, the substrate, is usually the limiting factor in bonding.

The substrate must be free from dust and loose or friable particles with low adhesion. Furthermore, the surface must be prewetted in order to prevent the bond area drying out, due to the absorption effects of freshly excavated dry rock, or previous layers of shotcrete. The force of the cleaning operation depends on the internal cohesive strength of the substrate and the water requirement is based on the inherent moisture content of the surface.

The surface must be wetted immediately before every spraying spraying to prevent a layer of dust being formed. The same applies if the sprayed concrete is to be built up layer by layer. In areas with high water ingress, pre-sealing of the surface and/or draining of the excess water is necessary.

## 7.3 SPRAYING

Sprayed concrete and mortar are applied in layers, either in the same operation by repeatedly spraying over the same area, or in a subsequent operation after a break. After a long break the surface must be cleaned and wetted again. The amount of material that can be applied in one operation depends on various factors:

- Adhesive strength of the sprayed concrete mix
- Nature of substrate or base layer
- Spraying process
- Spray output
- Spraying direction (upwards, horizontally)
- Obstructions (reinforcement/water ingress)

Different approaches are required for different spraying directions. When spraying downwards, layers of any thickness can be applied. Make sure that the rebound is either embedded or disposed of, so that it does not remain on the surface. When spraying horizontally, the required thickness can be built up gradually in thin layers, or for very thick applications, the full thickness can be applied from below the slope spraying upwards in layers. Here again the rebound must be removed from the bottom before applying the next layer.

When spraying overhead, the materials weight and the adhesion of the sprayed concrete to the substrate, effectively counteract each other so that several thin layers have to be used for the required total layer. As a general rule, a lower spray output and thinner layers generate less rebound, giving a better result in the end.

The sprayed concrete must be applied at right angles to the substrate or blinding concrete. This maximizes adhesion and compaction as well as minimizing rebound. The sprayed concrete or mortar is applied manually or mechanically in circular movements evenly over the whole surface. Spraying onto steel reinforcement is particularly difficult and requires experience, because cavities due to spray shadows under reinforcement are a serious potential issue. Incidentally, where appropriate this problem is avoided by using fiber reinforced sprayed concrete.

The optimum distance for spraying is usually within the range of one to two meters (for robotic spraying), but this has to be determined for each individual case. If the nozzle distance is too small, this will result in higher dust and rebound formation. If the nozzle distance is too large, the shotcrete will not be sufficiently well-compacted on the substrate.

### Application Rules of Spraying

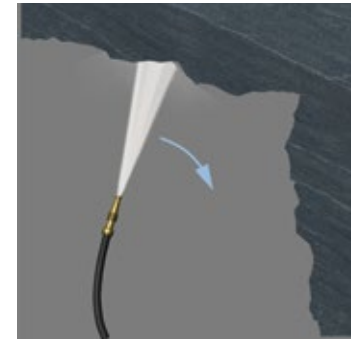

Fig. 7.1: Cleaning substrate from dust with water



Fig. 7.2: Filling of overbreaks

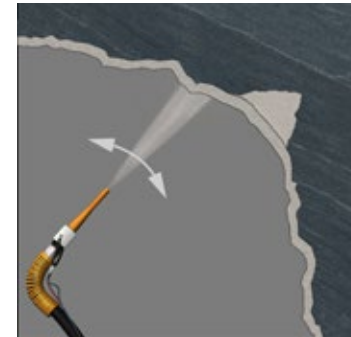

Fig. 7.3: 1st shotcrete layer – 1<sup>st</sup> excavation stabilization and adhesive bridge for the 2<sup>nd</sup> shotcrete layer

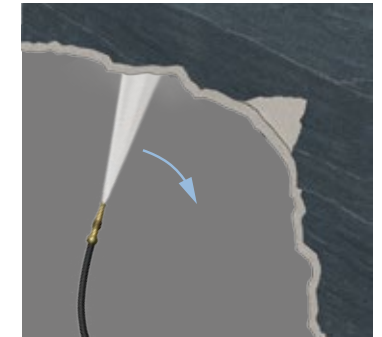

Fig. 7.4: Removing of dust with water after longer breaks

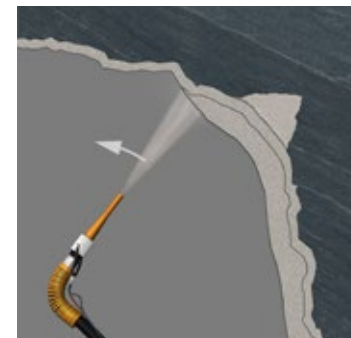

Fig. 7.5: 2<sup>nd</sup> shotcrete layer – excavation stabilization, usually together with steel reinforcement

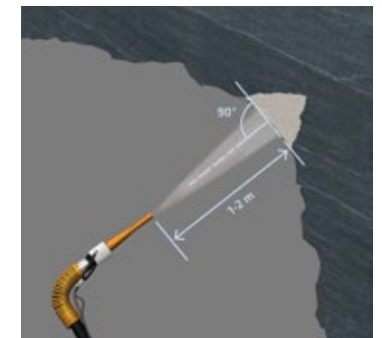

Fig. 7.6: Correct nozzle manipulation – too much air causes rebound and too high output causes lamination

Table 7.1: Wet shotcrete parameters and their influence on various properties

	Parameter	Recommendations and Limits	Improving of ...											Reduction of ...																								
			Hydration reaction	Strength development	Pumpability	Bonding to substrate	Internal cohesion	Workability time	Mixing of accelerator and shotcrete	Environment, health & safety	Cylinder filling	Accelerator efficiency	Compaction of shotcrete	Quality of shotcrete	Efficiency in shotcreting	Concrete tackiness	Rebound of shotcrete	Bleeding of concrete	Blockage in the equipment	Wear in the equipment	Lamination in shotcrete caused by pulsation	Inhomogeneity in shotcrete	Admixtue need (acceleration / retardation)	Adhesion failure in shotcrete	Extra time for shotcreting	Extra cost due to bad application	Dust generation											
Mix Design	Binder	400 - 500 kg/m <sup>3</sup>	x	x	x	x																																
	Aggregates	60 % of 0 - 4 mm / 40 % of 4 - 8 mm / 4 - 9 % of ≤ 0.125 mm			x	x																																
	Water	w/b 0.45 - 0.50	x		x		x																															
	Superplasticizer	0.8 - 1.2 %		x	x				x	x			x																									
	Accelerator	5 - 8 %, alkali-free		x		x						x																										
Fresh Concrete	Flow table spread	550 - 650 mm over minimum 2 hrs			x					x										x	x																	
	Slump	180 - 220 mm over minimum 2 hrs			x					x										x	x																	
	Air void content	3 - 8 %			x					x											x																	
	Temperature	15 - 25 °C	x	x					x																	x												
Application	Output	≤ 75 % of maximum output performance											x	x						x	x												x					
	Distance	1.5 - 2 m																																				
	Angle	90°																																				
	Air	4 - 5 bar									x																											
Condition	Substrate preparation	scaled, cleaned, drained, moist					x																															
	Temperature	> 10 °C	x																																			
	Nozzleman	well-educated																																				
	Equipment	well-maintenanced																																				



## 7.4 NOZZLE CONFIGURATIONS

The spray nozzle is one of the most important elements of the spraying system and represents the main wearing part in the sprayed concrete process. The thorough mixing of air, concrete and setting accelerator takes place inside the nozzle. In the context of shotcrete, the term nozzle refers to the entire configuration consisting of the converter or water ring and the spray tip. Inside the nozzle, the concrete base mix, initially passes through a converter (wet, dense flow) or a water ring (dry, thin flow):

- At the converter, the dense flow is changed to a thin flow with the help of compressed air, which also delivers the accelerator into the shotcrete.
- The water ring is used for the addition of batching water into a dry mix, which might optionally also add an accelerator.

After the converter or water ring, the thin flow mix passes through the nozzle tip wherein the mix is further homogenized and the final jet is shaped. Modern nozzle tips are made of special polymers with optimally balanced shape and material properties, designed to achieve a correctly mixed and applied shotcrete. The good condition of the entire nozzle system, i.e. the converter and the nozzle tip, is necessary for good shotcreting results. Shotcrete is produced from a holistic construction process comprising materials and the process. Any equipment that is worn or in poor condition, and in particular the nozzle, has a significant influence on the result of this process.

The different combinations of shotcrete materials and processes result in different nozzle configurations. The different shotcrete components are then brought together and homogenised in a suitable manner. In the end, regardless of the selected spraying process or material, a suitable, high-quality shotcrete is obtained. The typical material combinations and nozzle configurations are depicted in Figure 7.7 to 7.9, respectively.

The nozzle configuration depends, as well as on the process as on the choice of accelerators. Alkaline accelerators are preferably added two to five meters ahead of the nozzle. This ensures better mixing with the concrete and allows a slightly extended reaction time. As a result, less dust and caustic accelerator mist are produced and better results in the early strength range are achieved. All of the potential problems with caustic materials are eliminated by using alkali-free accelerators. The addition of alkali-free accelerators, however, should be performed right at the nozzle, not upstream, as they are extremely reactive initially.

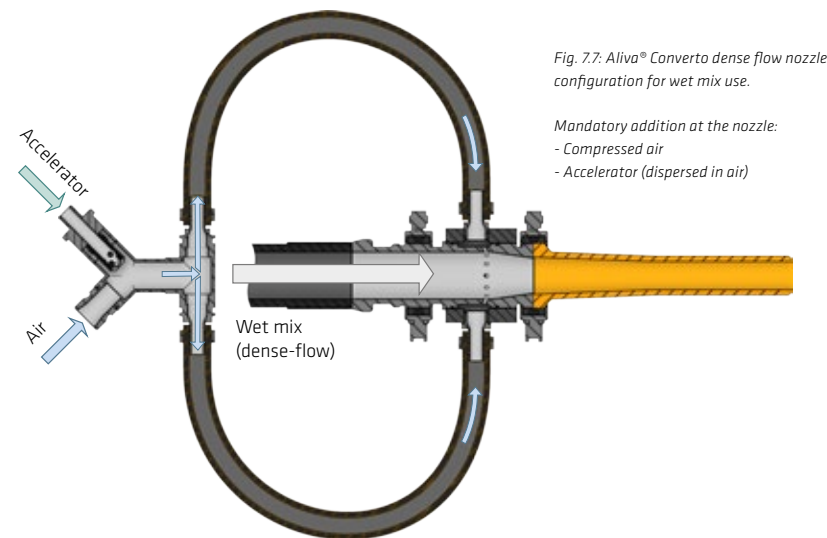

Fig. 7.7: Aliva® Converto dense flow nozzle configuration for wet mix use.

Mandatory addition at the nozzle:  
- Compressed air  
- Accelerator (dispersed in air)

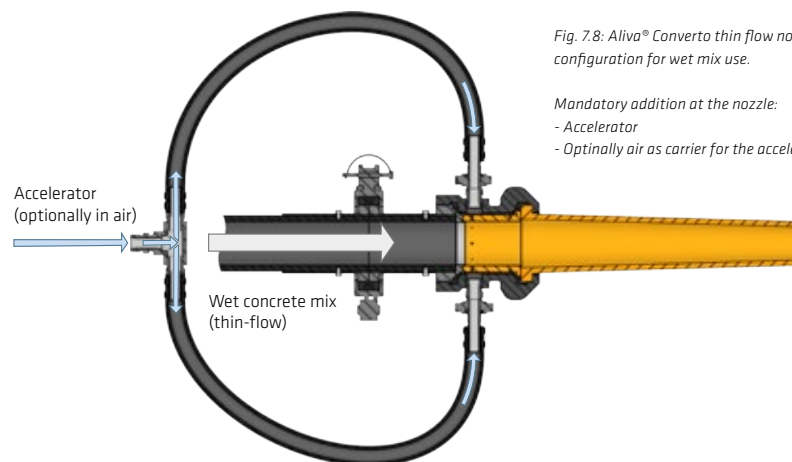

Fig. 7.8: Aliva® Converto thin flow nozzle configuration for wet mix use.

Mandatory addition at the nozzle:  
- Accelerator  
- Optimally air as carrier for the accelerator

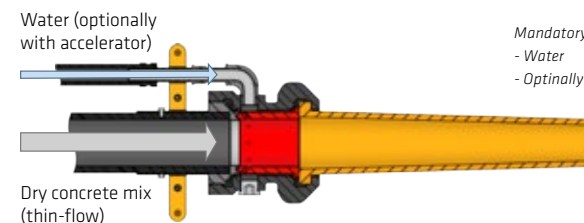

Fig. 7.9: Aliva® Converto thin flow nozzle configuration for dry mix use.

Mandatory addition at the nozzle:  
- Water  
- Optimally accelerator (dissolved in water)

High-quality nozzles are designed to focus the jet and taking all the material to the substrate without loss, thereby distributing particles evenly over the cross-section of the jet.

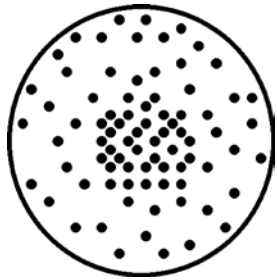

Fig. 7.10: Poor distribution of the particles over the cross-section of the jet

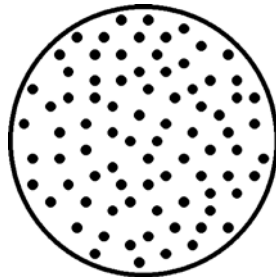

Fig. 7.11: Good distribution of the particles over the cross-section of the jet

## 7.5 REBOUND

Reducing rebound during the spray process is one of the most complex challenges for sprayed concrete. It is of great economic and logistic importance because any rebound means the increased wastage of materials and twice the working time required throughout. The influences on this issue are diverse and systematic control is unfortunately, extremely difficult. The most important factor is certainly the skill of the nozzleman. Their technical skills and experience will significantly influence the rebound quantity.

Factors influencing the rebound quantity include:

- Nozzleman's technical skills and experience
- Spraying direction (up, down, horizontal)
- Spraying parameters (air pressure, nozzle, spray output)
- Spray process (dense- / thin flow)
- Condition of the equipment
- Sprayed concrete mix design (aggregate, grading curve, accelerator, fibers, binder)
- Sprayed concrete performance (very early strength, adhesive strength, layer thickness)
- Substrate condition (evenness, cleanliness)

Rebound changes during the spraying process. At the very first moment, when the shotcrete directly hits the solid substrate, the rebound is much higher. Due to the high kinetic energy of the sprayed material, coarse aggregate in the first pass is lost as rebound. Accordingly, a thin layer of the remaining sand and binder paste is formed at the interface, which is forced by the pressure into the smallest cracks and cavities in the substrate surface, creating an excellent bonding layer.

Later the rebound decreases and the shotcrete also comprises more of all other components and particle sizes. The rebound quantity is then controlled by the adhesive strength of the sprayed concrete.

### Rebound Quantity

Without measurements of the actual rebound under the conditions prevailing on site, the quantity can only be roughly estimated. From experience the typical values in vertical shotcrete applications are:

- Rebound with dry sprayed concrete 20 – 30 %
- Rebound with wet sprayed concrete 5 – 15 %

### Reuse / Disposal

In principle, sprayed concrete rebound is a recyclable concrete material with all the components of the original mix. However, this must be confirmed as it could be contaminated (polluted) by any adverse conditions and exposure on site. As with structural concrete, a small proportion of 10 – 20 % max. of correctly treated sprayed concrete rebound can be reused in the aggregates.

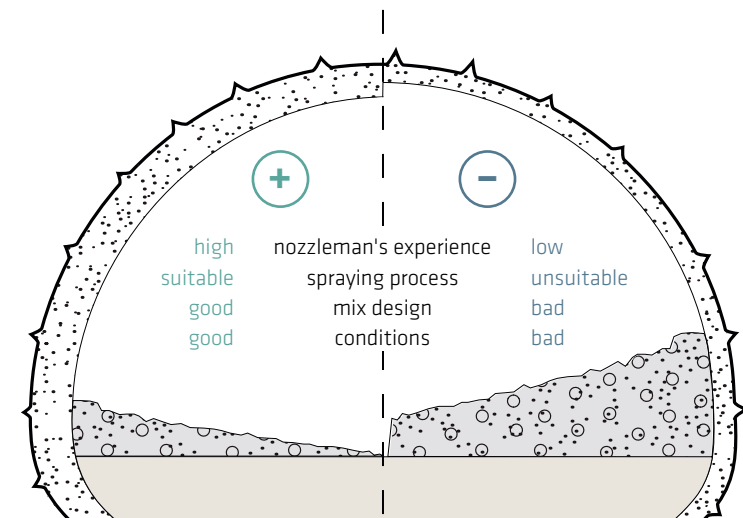

Fig. 7.12: Influences on rebound

## 7.6 DUST DEVELOPMENT

Dust occurs with any type of sprayed concrete application, but the dust quantities and types differ considerably. With dry sprayed concrete there is a major dust issue since the components have a natural tendency to generate dust. The amount of dust generated can be reduced by several means, including:

- Use of earth-moist aggregates (instead of oven dried)
- Good maintenance / sealing of the rotor machine and the entire conveying system
- Correctly adjusted and balanced parameters at the nozzle (minimal air, sufficient water, minimal accelerator)
- Low pulsation during material conveyance
- Use of alkali-free shotcrete accelerators
- Use of spray manipulators for outputs > 6 m<sup>3</sup>/h
- Sprayed concrete admixtures to effectively fix the deposited dust

Despite all these measures, two to four times more dust will be generated by dry sprayed concrete than by the wet sprayed methods. To further improve safety on site, only alkali-free shotcrete accelerators should be used.

## 7.7 SPRAY SHADOWS WITH WIRE MESHES

If a shotcrete lining with higher energy absorption is required, the shotcrete can be combined with mesh reinforcement. A problem resulting from this, however, is the potential for so-called spray shadows, which can occur during spraying on the rear side of wire meshes that negatively influence the static properties of the overall shotcrete lining.

An experienced nozzleman can minimize spray shadows by selecting the correct spraying sequence and suitable spraying parameters. When backfilling reinforcement adjustments such as in the delivery rate, compressed air (possibly increasing), the accelerator dosing (possibly reducing) and the spraying approach as a whole must be adapted to the poor accessibility. The importance of the nozzleman for these situations is clear as the main criterion for high-quality sprayed concrete.

Alternatively, instead of reinforcement using steel mesh, fibers are an alternative, as spray shadows are not an issue. In addition, its installation is considerably easier, faster, and safer, as no one has to work in the unsecured driving area before the shotcrete is applied.

## 7.8 LAYERING, LAMINATION AND COLD JOINTS

Shotcrete is applied onto the substrate with high energy. This results in the hard substrate being roughened by the aggregates and more importantly, the rebound from the hard substrate results in cement paste accumulating as a layer in the intermediate zone between the substrate and the shotcrete. This cement-enriched zone acts as a bonding bridge and increases the adhesive strength between the substrate and the shotcrete shell.

Following the first bonding layer, the shotcrete is applied in several layers and in order to obtain a good, homogeneous shotcrete lining, the individually applied thinner shotcrete layers must be sound in themselves and with a good bond between the layers ensured. For shotcreting over previously applied shotcrete layers, where setting has not started long ago, the fresh shotcrete aggregates will penetrate into the still soft previous shotcrete layer and will lead to intermixing of the layers.

Adverse layering and lamination generally happens when guidelines (mainly the substrate preparation) are not properly followed, or when the mixing of concrete, compressed air and accelerator at the nozzle is poor (e.g. partially blocked holes in the injector), and when the filling rate of the pistons or rotors is poor. Non-homogeneous mixing, low compaction on the substrate, entrapped dust, excess accelerator, and strong pulsation of the spray jet, can all lead to adverse layer formation / laminations in the applied sprayed concrete.

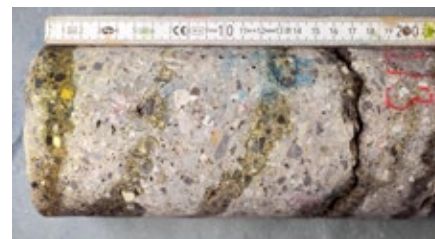

Fig. 7.13: Well visible spraying layers in a drill core

In order to avoid such layering or lamination within the shotcrete shell, all of the relevant parameters have to be optimized individually, as well as in their interaction, which again means the components in terms of the materials, equipment, and application (nozzleman skills, spraying rules):

- **Materials**  
If the base mix is too stiff/ tacky, both pumpability and sprayability will be adversely affected. The filling degree of the cylinders becomes lower, which results in a stronger pulsation when the pistons change. Furthermore, the entire spraying process and compaction on the substrate become difficult. A fluid shotcrete is important to achieve good, homogenous mixing with the accelerator at the nozzle and a good bond and interaction of the sprayed material in the fresh shotcrete with previous layers.
- **Equipment condition**  
As a prerequisite for a homogenous (non-laminated) shotcrete lining, the shotcrete jet should exhibit minimal pulsation. For this, all parts of the spray rig have to be working correctly and synchronize feeding the individual shotcrete components to the nozzle. Also an inaccurate (not horizontal) positioning of the spraying machine leads to a lower filling level of the pump cylinders and thus to a stronger pulsation and layer formation.
- **Application**  
Nevertheless, in the end it is the nozzle man, whose experience and skills have a significant influence on the shotcrete quality and thus also on possible layer formation. A systematic approach to the spraying process, e.g. according to the spraying rules of EFNARC, is just as important as working within the reasonable performance range of the machine: too high a spraying performance, despite all other good parameters, again has a negative influence on the cylinder filling and thus increased pulsation.

# 8 SHOTCRETE QUALITY MANAGEMENT

It is quite a challenge to define all the most suitable parameters for good quality shotcrete (economy, technology, logistics, concrete, admixtures, environment) without the specific requirements and conditions for a certain construction site. These must therefore be defined for each project before the main site works has started. It can sometimes be even more a challenge to maintain all this constantly and consistently working well throughout the entire construction period, which on larger projects can last for several years.

Shotcrete is a holistic system, not simply a special mix design, or a specific type of equipment, or concrete application. There are a large number of parameters that, due to their balanced interaction, help to ensure a safe working situation underground, or if quality control decreases - can cause issues and failures of the shotcrete system. Thus, the requirements for all the different parameters and their quality assurance are very high.

Usually, quality control is performed periodically which, in the event of a loss of quality, quickly becomes crucial in order to securely locate and eliminate the cause of any such issue and potential failure, as soon as possible. In addition to quality assurance, a constructive interaction between all of the project participants is particularly important.

The various measures that are available for quality control at all stages of shotcrete production, either on site or at the laboratory are outlined in the following.

## 8.1 RAW MATERIALS AND SHOTCRETE QUALITY

Shotcrete is based on a specific combination of materials that are subject to individual quality control, and in addition there are special requirements for its application:

### 8.1.1. Shotcrete base mix

- *Cement* is adjusted and monitored by the cement producer regarding its chemical composition, mineralogy, fineness, and reactivity (with water).  
Typically, there are no additional QC measures with regard to the use of the cement in shotcrete applications and the resulting chemistry. The cement admixture combination has to be well tested in advance of the project and the findings from these tests should be re-confirmed, regularly. The entire complex set of acceleration reactions in shotcrete is strongly dependent on the correct interaction of all components and the cement chemistry can be influenced by even small deviations, such as in the quality of the batching water.
- *Aggregates* are monitored by their producers to confirm their nature, grading, moisture and fines contents.  
The entire grading curve of the aggregates is important for the workability of wet-sprayed shotcrete. Cohesion, pumpability, and adhesion to the substrate are also important shotcrete issues that are directly related to the aggregates. The fines fraction of the aggregates can also have an impact on the shotcrete chemistry, specifically on the early strength development.
- *(Reactive) additives* are monitored by their producers and to standards for their chemistry, grading, and the pozzolanic reactivity.  
Similarly to cement, with reactive additives the specific chemistry of shotcrete applications is not taken into account and therefore the selection and use of these materials should be tested (and confirmed again, later on) for their use in specific mix designs. Here once again, tiny changes in their composition may have a significant effect on the acceleration of young shotcrete.
- *Water* always has to be specifically tested for each project, especially when it is not potable tap water (natural spring or recycling water), e.g. testing to confirm the ion content, e.g. for chlorides, sulphates or organic impurities, as well as its pH.  
Especially when using recycling water from the site, its inorganic chemistry may be important to confirm for its suitability in shotcrete, but usually this is not tested. The potential ionic contamination (sulphates, aluminum and calcium ions) of recycling water should be quality assured regularly.
- *Admixtures* for concrete and shotcrete originate from industrial chemical producers and, therefore, are subject to regular and very thorough monitoring and strict certification (e.g. CE). This includes inspection and testing of incoming chemical raw materials (specifications, impurities) as well as the production control of the admixture materials (production procedures, specifications, chemical impurities or purity, effect in the intended product use).  
Admixtures for shotcrete are also specifically tested with respect to their intended use in shotcrete. The specific situation with shotcrete accelerators is further outlined below.

- The base mix itself has to be continuously monitored regarding its fundamental properties, especially its plasticity/flowability, water and air content, and its cohesion.

### 8.1.2. Shotcrete production

- The *equipment* used for shotcrete spraying is specifically engineered for its suitability in this process. The producers of these units have a high level of competence regarding this construction process and the specific demands for the used products. In the course of a project, the condition of the spray rig must be continually assured. This requires good and regular maintenance, with a good balance between the volume flows and the wearable parts and consumables that must always be controlled. The nozzle system and its condition is particularly important.  
Most mechanical workshops, even on larger construction sites are generally not specialized in shotcrete technology, of course. Therefore, it is always recommended that the manufacturer of the spray equipment should be consulted regularly.
- *Nozzlemen* have a high level of responsibility. Their specialist knowledge and practical skills are essential for good shotcrete results and the associated safety for underground construction. Suitable specialist training as well as certifications are available, but these are not yet universally recognized and required. For example, there are the Shotcrete Nozzlemans Certification from the American Shotcrete Institute (ASI) and the Nozzlemans Certificate from EFNARC in Europe. These certificates ensure that the nozzlemen are well trained and their abilities are confirmed regarding materials, equipment, and the entire shotcrete construction process. The aim is to ensure the quality of the shotcrete application (workers safety), as well as the quality of the applied shotcrete lining as a whole (workers safety during early age shotcrete protection, as well as safe working in the excavation area).
- *Environmental conditions* also play an important role regarding shotcrete quality. For example there are important differences and effects if shotcrete is applied underground or above ground, using more or less cold materials, with strong ventilation, or with low/high levels of humidity.  
The temperature of the materials and environmental conditions substantially affects the performance of young shotcrete up to 24 hours. Especially, if the temperature of the base mix is lower than 15°C, then its use in shotcrete becomes seriously dangerous. The loss of humidity in young shotcrete plays an important role in the shotcrete quality, as during the initial maturing of the cement, which is the phase of the strongest cement hydration, high moisture loss through low environmental humidity or excess ventilation, would result in inadequate cement hydration and a lower quality of shotcrete.  
For shotcrete, especially in overhead positions, typical concrete curing measures do not work. In tunneling and mining, however, the ambient humidity is usually high enough and does not require specific curing measures to ensure a suitably low moisture loss from the surface. If this is not the case (very dry environment, strong ventilation), internal curing agents are still not recommended for shotcrete since they can also adversely affect early strength development and reduce the bond of subsequent shotcrete layers. If really necessary, other suitable measures must be taken, e.g. to actively moisten the shotcrete surface for an appropriate time.

## 8.2 QUALITY CONTROL ON SITE

Continuous, regular quality control monitoring on site is highly recommended for shotcrete applications. There are minimum measures which should be ensured and documented, including:

- **Batching protocol:**  
Planned and realized mix design with listing of the dosed quantities of all components.
- **Fresh Concrete Testing:**
  - General appearance of the mix (non-bleeding, cohesive)
  - Consistency of the mix: slump or flow table spread
  - Air void content
  - Water content
  - Ensuring the grading curve (aggregate certificates & mix design)
  - Paste volume (mix design, grading curve, cement & additives content)
  - Paste quality (w/c- or w/b-ratio, cohesion, bleeding, ...)
- **Spraying documentation:**
  - Equipment settings (concrete feed rate, cement content of the base mix, accelerator density and dosage)
  - Equipment parameters (feed rates of concrete and accelerator, hydraulic pressure, air pressure)
  - Substrate preparation

Table 8.1: Quality check for sprayed EFNARC-Referenz

Process Step	Subject	Test Item	Frequency
Components	Aggregates	Moisture Grading curve	Each delivery Periodically
	Cement / Additives	Delivery documents	Each delivery
	Admixtures	Delivery documents	Each delivery
Concrete production	Mixing plant	Scales, mixer, etc.,	According to maintenance plan
	Concrete production	Mix design	Each batch
	Fresh concrete testing	Water content Fresh concrete density Temperatures (concrete / air) Consistency Air content	Periodically
Transport	Hauling equipment	Maintenance	According to maintenance plan
Application	Sprayed concrete unit	Maintenance Accelerator dosage	According to maintenance plan Daily
	Sprayed concrete	Consistency Strength development Final compressive strength Durability Rebound	According to test plan

- **Shotcrete performance testing**
  - Visually (sprayability, vertically and over head)
  - Early strength measurement (0 – 24 h) using penetration needle and stud-driving tests. Shotcrete to be applied overhead should achieve a minimal strength development of J2 according to the European Standard for Shotcrete.
    - > Rule of thumb: for overhead application should be ensured at about
      - 1 MPa after 1 h
      - 4 MPa after 4 h
      - 10 MPa after 24 h
  - Energy absorption testing for fiber reinforced shotcrete

### 8.2.1 STRENGTH CLASSES AND PERFORMANCE OF YOUNG SHOTCRETE

The main use of shotcrete is for underground excavation stabilization. Accordingly, safety has the top priority here. An essential quality feature of shotcrete, therefore, is its very early strength development, i.e. from its initial stiffening up to 24 h.

Depending on the intended use, the strengths of freshly-applied sprayed concrete are divided into three classes: J1, J2 and J3 (Austrian Sprayed Concrete Guideline, EN 14487).

- Class J1 sprayed concrete is appropriate for application in thin layers on a dry substrate. No structural requirements are to be expected in this type of sprayed concrete during the first hours after application.
- Class J2 sprayed concrete is used in applications where thicker layers have to be achieved within a short time. This type of sprayed concrete achieves a rapid load build-up and can be applied overhead to build up a reasonable shotcrete lining, suitable for excavation stabilization. This kind of shotcrete is part of the usual working cycle in drill & blast underground construction.
- Class J3 sprayed concrete is only used under special circumstances, e.g. for highly fragmented rock or strong water influx. Due to its rapid setting, more dust and rebound occurs during the application of this shotcrete material.

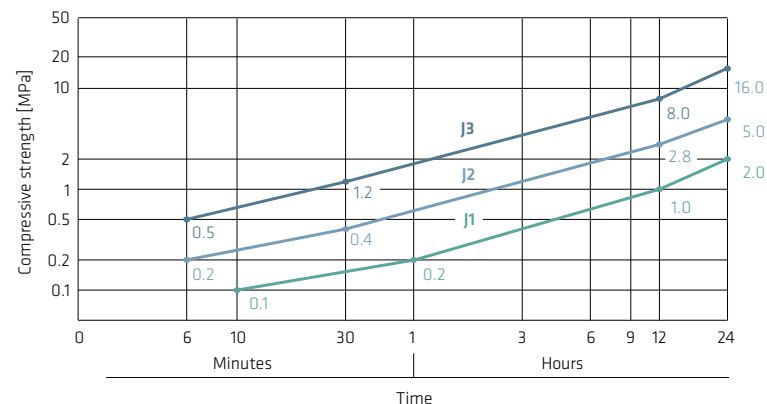

Fig. 8.1: Shotcrete early strength classes according to EN 14487-1



The compressive strength properties of young shotcrete (0 – 24 h) change over a wide range and have therefore to be measured by two different methods, depending on the magnitude of strength: By handheld penetrometer measurement and by stud-driving. Both methods make use of the correlation between the force required for a needle to penetrate and the compressive strength of the specimen.

One has to keep in mind that any correlation function for the assessment of these testing data is necessarily an approximation. There are many different parameters that can influence the results for these methods, which means they can exhibit a very high data deviation preventing them from being a really reliable measurement. There is a particular dependence on these testing procedures for mix design and aggregates, for homogeneity of the spray application (equipment, nozzle man) and, last but not least, on the operator of the testing devices. Accordingly, this kind of quality control data cannot be taken and assessed as a scientifically profound data set, but it is the most suitable and practical procedure to ensure a reasonable knowledge and monitor safety expectations on site.

Nevertheless, the first 24 hours from spraying always represent the most critical time range with respect to safety issues in underground construction works:

- Shotcrete is considered to stay safely on the substrate, even overhead, in a suitable layer thickness. To achieve this, a constant compressive strength increase within a specified strength class has to be achieved.
- The initial strength gain is the effect of the acceleration reaction, mainly during the first 60 – 90 minutes. As a rule of thumb this is successfully achieved if the compressive strength - estimated with the penetration test - reaches the threshold of 1MPa at 1h.
- The subsequent compressive strength gain is mainly due to the cement hydration reaction, starting about 2-3 h after spraying and continuing throughout the curing of the shotcrete. To ensure this has happened properly, the stud-driving method is used and gives reasonable evidence, e.g. if the gain is by ca. 4 MPa at 4 h (and ongoing, increasing up to 10 – 15 MPa at 24 h).

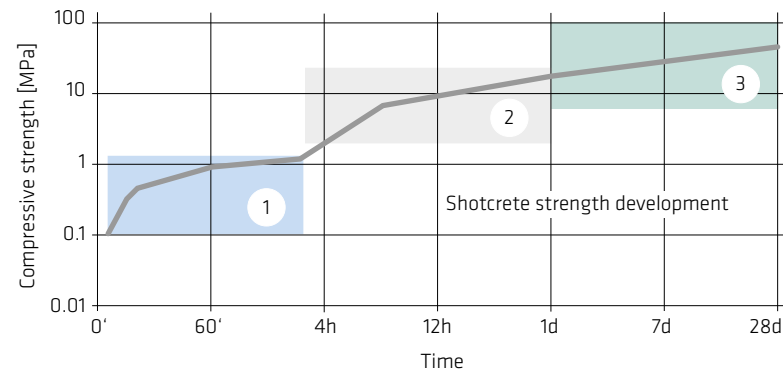

Fig. 8.2: Methods for strength development measurement

Table 8.3: Methods for shotcrete performance measurement

Development of	Method	Instrument	Compressive strength	Time	
1	Initial strength	needle penetration	Penetrometer	up to 1.5 MPa	0 – 3 h
2	Early strength	stud driving	Hilti DX 450-SCT	3 – 20 MPa	3 – 24 h
3	Final strength	coring	Compression testing machine	5 – 100 MPa	1 – 28 d

### 8.2.1.1 NEEDLE PENETRATION METHOD

The needle penetration measurement procedure is specified in EN 14488-2 and this confirms a suitable acceleration reaction has occurred in the shotcrete.

The needle penetration method determines the force required for a given penetration depth, e.g. a reading is given by a load cell. A suitable correlation of the penetration force which is required for a 3 mm needle to penetrate 15 mm of the specimen's surface results in the equivalent strength of the tested material. The tip of the needle has an angle of 60°. Usually, the average of ten individual readings per measurement is used for the compressive strength calculation.

The needle penetration method does not require any special specimen preparation but can be performed at any sprayed concrete area on site with a layer thickness of at least 50 mm and that is safely accessible (no fresh shotcrete overhead!).

### Compressive Strength in Young Shotcrete

The material properties of shotcrete especially during its first hour(s) are characterized by a gradual transition from plastic to solid. The term “compressive strength” is not physically accurate, as the initial needle penetration measurement describes the change of plasticity towards the compressive strength, without making a precise distinction between these. When speaking about the initial compressive strength of shotcrete it has to be understood that this is not an exact physical measurement of compressive strength, but a useful simplification to compare the suitability of the sprayed concrete.



Fig. 8.3: Penetration of freshly sprayed concrete using a digital penetrometer (Mecmesin AFG 1000)

### 8.2.1.2 STUD-DRIVING METHOD (HILTI)

In order to determine the compressive strengths between ca. 3 MPa and 20 MPa, which is typically representing a time range from a few hours till one day, a stud is driven into the specimen surface at a given load and then subsequently it is pulled out. The compressive strength of the specimen is calculated with the help of calibration curves from a combination of the penetration depth and the extraction force.

The stud-driving method is specified in EN 14488-2 and this is used to ensure that the cement hydration in young shotcrete has appropriately started and continues.

Basically, the stud driving method is based on the same physical principles as the needle penetration method to obtain a figure having the meaning of a compressive strength. The consideration of the extraction force for the calculation of this figure is actually only applied as a correction which reduces the degree of data scattering.

For accurate readings it has to be ensured that the penetration depth of the stud is at least 20 mm and that the protruding part of the stud is not bent. The latter would result in misreadings as a substantial part of the applied load energy is absorbed by the deformation.



Fig. 8.4 / 8.5: Penetration of young sprayed concrete with studs using a Hilti DX 450-SCT (left) and measurement of the stud protrusion for the determination of the penetration (right)

### 8.2.1.3 DRILL CORE METHOD

The final compressive strength is determined using concrete drill cores according to EN 12504-1 "Testing concrete in structures".

The preparation of specimens in dimensions suitable for usual compressive strength measurements is virtually impossible by direct spraying into molds, especially when considering that specimens should be placed and cured at conditions equal to the shotcrete on site. Accordingly, specimens for compressive strength measurements, e.g. to determine the 28 d strength and any eventual strength loss compared to the base mix due to the spraying process, are typically cored after a suitable curing period (e.g. 7 d) either directly from the wall or from representative sprayed panels, which are prepared during the shotcrete application on site, so under comparable conditions.



Fig. 8.6 / 8.7: Core drilling from sprayed concrete sample (left) and compressive strength measurement of a drill core (right)

## 8.3 QUALITY CONTROL AT THE LABORATORY

For larger, multi-year underground projects, accompanying the construction process using a more detailed monitoring on a laboratory scale would be advisable. On the one hand, this will prevent the development of any serious damage or work flow interruptions, and on the other hand, will be able to find quick solutions to any problems or issues that may arise. Laboratory testing affects applied samples as well as for the shotcrete materials.

The typical tests with site samples are:

- Compressive strength testing of drill cores (1 – 28 d strength) as well as of cubes from the base mix (28 d). The testing of drill cores should always include the documentation of the specimen with visual properties (homogeneity, layering, density/compaction), as these also give a good indication of the state of the equipment and/or the quality of the spraying.
- Energy absorption testing of fiber reinforced shotcrete panels. Whenever shotcrete is reinforced using fibers, the required energy absorption should be confirmed by regular testing of sprayed samples from site. This procedure ensures that all relevant process steps are considered with respect to the effective mix design and potential fiber loss with the rebound.

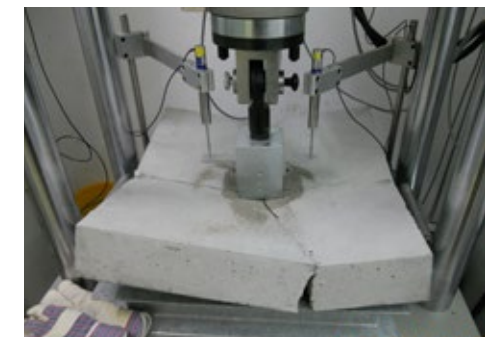

Fig. 8.8: Energy absorption testing of fiber reinforced sprayed concrete according to EN 14488-5

In addition to the usual concrete materials quality monitoring on site, further laboratory testing can be applied, especially for the chemically reactive components (cement, SCM, water, admixtures) of shotcrete:

#### *Detailed Cement Analyses*

Cement is a natural product which due to its raw material and processing undergoes certain deviations over time, potentially affecting the acceleration in shotcrete.

Next to its chemical composition, the mineralogy and fineness of the cement can have a substantial impact on the shotcrete performance and this can be monitored by powder X-ray diffraction (XRD, mineralogy), nitrogen adsorption (BET, specific surface area), or laser granulometry (particle size distribution).

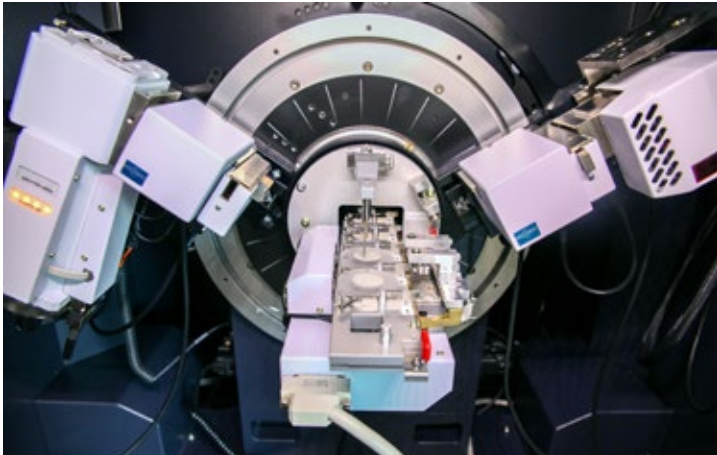

Fig. 8.9: Powder XRD measurement

#### *Chemical Analysis of the Batching Water*

Chemical impurities in the batching water can strongly affect the acceleration reaction, especially with recycled water from site, deviations over time must also be considered with regard to their high potential for causing shotcrete performance failures. The batching water should be closely monitored by regularly chemical analysis.

#### *Sika® MiniShot Testing of Shotcrete Acceleration*

The accelerator composition is, due to its production process, quite constant, however, it has to interact in a potentially changing chemical environment. Setting tests are used to validate other cementitious materials, but exclude the highly specific mixing process at the shotcrete nozzle. A laboratory screening of the cement–water–accelerator interaction, necessarily has to integrate this process conditions which is achievable using a modern laboratory spraying device such as the MiniShot testing system (Figure 8.10 / 8.11). This laboratory testing system allows monitoring of chemical interactions in a given shotcrete system, by using the equivalent paste from the shotcrete. The equivalent paste is sprayed under similar physical conditions to the original shotcrete and then the acceleration and early strength development of the paste is constantly monitored using ultrasound spectrometry (Sika® Pulsment).



Fig. 8.10/ 8.11: Sika® MiniShot spraying at the laboratory



# 9 TROUBLESHOOTING GUIDE

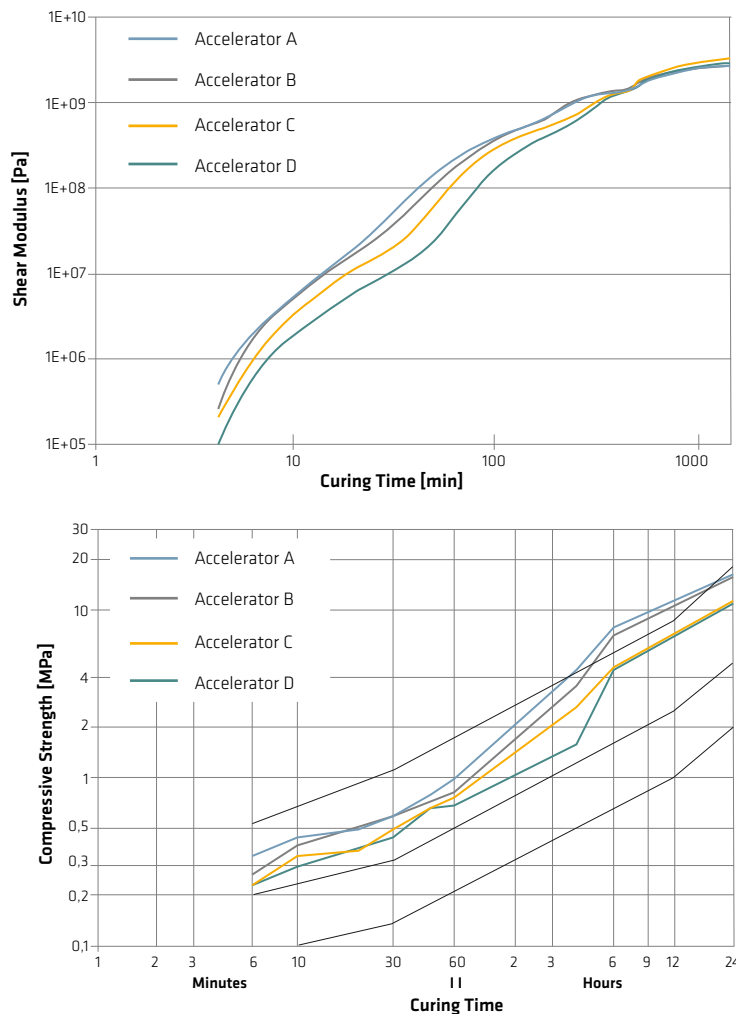

Fig. 8.12: MiniShot laboratory results (top) compared to field tests (bottom) for identical base materials (cement, batching water, fines from aggregates, and admixtures).

Results from this test do not allow a prediction of the absolute compressive strengths on site, but give an excellent qualitative comparison. The shear modulus determined in this process is a direct measure of the viscosity of the paste, which essentially represents the change in shotcrete compressive strength (Figure 8.12). When MiniShot monitoring is applied regularly, a deviating shotcrete quality on site can be correlated to the origin of the problem, e.g. originating from the cement, admixtures, or batching water.

Note: Tests typically used in mortar or cement qualification testing, such as the Gillmore or Vicat needle test, are not suitable for testing the setting of accelerated pastes or mortars to represent shotcrete properties. These methods are not valid or reliable for shotcrete because the specific materials mixing and spraying is not considered.

Table 9.1: Troubleshooting guide for shotcrete performance problems

Problem regarding	Approach	Troubleshoot
Compaction	Optimization of matrix by adjustment of mix design	Steady sieve curve Content of fines > 450 kg/m <sup>3</sup> Addition of additives
	Increasing of compaction energy	Nozzle distance 1.5 – 2.0 m Air pressure 3.5 – 4.5 bar Cleaning of spraying head
Early Strength	Improving of concrete setting and hardening	To check the accelerator consumption
		Reduction of w/c- or w/b-ratio
		Increasing of cement content
		Increasing of accelerator dosage
		Increase concrete temperature
		Ensure proper curing conditions (temperature)
Mixing	Reduction of stickiness	Changing of accelerator type
		Using of cement with high C <sub>3</sub> A content
		Using of cement with higher grinding fineness
	Improvement of shotcrete homogeneity	Reduction of fines content
		Increasing of water content
		Changing of superplasticizer type
Lamination / layering	Increasing of cylinder filling	Increasing of superplasticizer dosage
		Increasing of air void content
		Machine maintenance
		Air pressure 3.5 – 4.5 bar
		Using of spraying head rotator
		Cleaning of spraying head
		Reduction of concrete output
		Using of free-flowing concrete (F5-F6)
		Ensure appropriate hopper filling
		Machine maintenance

Table 9.2: Troubleshooting guide for shotcrete pumpability problems

Problem regarding	Approach	Troubleshoot
Shotcrete performance	Improving of concrete setting and hardening	Increasing of concrete temperature
		Aiming a low w/c-ratio
		Increasing of cement content
		Increasing of accelerator dosage
		Using of cement with high C <sub>3</sub> A content
		Using of cement with higher grinding fineness
		Avoiding of concrete temperature loss
Blockage	Improvement of pumpability	Steady sieve curve
		Increasing of fines content
		Increasing of water content (avoid bleeding!)
		Increasing of superplasticizer dosage
		Using of Sika® Stabilizer Pump (improved workability)
		Reduction of concrete output (< 10 m <sup>3</sup> /h)
		Using of SikaPump®-Start 1 (or lubrication mix)
		Increasing of air void content
		Using of SikaTard® (improved workability time)
		Extension of mixing time for fibers
Malfunction	Fault analysis according manual	Fault correction according troubleshooting guide

# 10 STANDARDS AND GUIDELINES RELATED TO SHOTCRETE

This section is intended to give just an overview of standards that are specifically dealing with shotcrete. There are many other standards related to concrete and its constituents that hold also for shotcrete, which are detailed in the Sika® Concrete Handbook.

## EUROPEAN STANDARDS

### ■ EN 934-5

*Admixtures for concrete, mortar and grout – Part 5: Admixtures for sprayed concrete – Definitions, requirements, conformity, marking and labelling.*

Definition and specification of requirements and conformity for admixtures specifically intended for use in sprayed concrete:

- set accelerating and non-alkaline set accelerating admixtures
- consistence control admixtures
- bond improving admixtures.

### ■ EN 14487-1

*Sprayed concrete – Part 1: Definitions, specifications and conformity*

Definitions, specifications, and conformity criteria of dry and wet sprayed concrete:

- classification related to consistence of wet mix
- environmental exposure classes; young, hardened and fiber reinforced concrete
- requirements for constituent materials, for concrete composition and for basic mix, for fresh and hardened concrete and all types of fiber reinforced sprayed concrete
- specification for early strength development

### ■ EN 14487-2

*Sprayed concrete – Part 2: Execution*

Details on how to correctly execute concrete spraying related to applications (ground strengthening, repair and upgrading of existing structures and for free-standing structures):

- requirements for the execution of concrete spraying both by wet and dry process
- applicable to temporary as well as permanent structures

## ■ EN 14488 - Testing Sprayed Concrete

*Testing methods of shotcrete requirements according to its specifications are described individually in Part 2 to Part 7.*

- Part 1: Sampling fresh and hardened concrete
- Part 2: Compressive strength of young sprayed concrete
- Part 3: Flexural strengths (first peak, ultimate and residual) of fiber reinforced beam specimens
- Part 4: Bond strength of cores by direct tension
- Part 5: Determination of energy absorption capacity of fiber reinforced slab specimens
- Part 6: Thickness of concrete on a substrate
- Part 7: Fiber content of fiber reinforced concrete

## ASTM STANDARDS

### ■ ASTM C1141/C1141M

Standard Specification for Admixtures for Shotcrete  
Compilation of the standards defining the requirements for sprayed concrete relevant admixtures and additives.

### ■ ASTM C1436

Standard Specification for Materials for Shotcrete

### ■ ASTM C1480/C1480M

Standard Specification for Packaged, Pre-Blended, Dry, Combined Materials for Use in Wet or Dry Shotcrete Applications

### ■ ASTM C1385/C1385M

Standard Practice for Sampling Materials for Shotcrete

### ■ ASTM C1604/C1604M

Standard Test Method for Obtaining and Testing Drilled Cores of Shotcrete

### ■ ASTM C1140/C1140M

Standard Practice for Preparing and Testing Specimens from Shotcrete Test Panels

### ■ ASTM C1550

Standard Test Method for Flexural Toughness of Fiber-Reinforced Concrete (Using Centrally Loaded Round Panel)

## GUIDELINES FOR SPRAYED CONCRETE

### ■ Austrian Society for Concrete Technology (öbv)

#### **Austrian Sprayed Concrete Guideline**

In view of the first edition in 1989 (application) and 1992 (testing) the Austrian Sprayed Concrete Guideline can be regarded as a pioneer of quality assurance in wet-sprayed shotcrete. All aspects of shotcrete materials, requirements, application and quality assurance are covered by this guideline.

### ■ European Federation of National Associations Representing Producers and Applicators for of Specialist Building Products for Concrete (EFNARC)

#### **European Specification for Sprayed Concrete**

Specification of shotcrete materials, mix design, requirements, application and quality control.

#### **Guidelines for Specifiers and Contractors**

Providing a commentary on the Specification by giving an explanation of the requirements.

### ■ Norwegian Concrete Association (NB)

#### **Publication no. 7 – Sprayed Concrete for Rock Support**

The Publication no. 7 is intended as a supporting document related to the European standards for the Norwegian shotcrete market. All aspects of product specification, materials, application, and shotcrete testing are compiled.

### ■ American Concrete Institute (ACI), Committee 506

#### **ACI 506.2-13(18), Specification for Shotcrete**

Specification of construction requirements for shotcrete application:

- Part 1: General. Definitions, Standards, Testing.
- Part 2: Products. Materials, shotcrete properties, proportioning, batching and delivery
- Part 3: Execution. Substrate preparation, application, finish, curing, repair

#### **ACI 506R-16, Guide to Shotcrete**

- Part 1: All aspects of shotcrete design and construction, on materials and testing.
- Part 2: Specification for Materials, Proportioning, and Application of Shotcrete.
- Part 3: Execution of shotcrete – surface preparation, application, finishing, curing.
- Part 4: All kind of equipment for dry and wet mix application.
- Part 5: Crew organization, qualification and communication.
- Part 6: Shotcrete sustainability, construction efficiency.



# 11 INDEX

<b>A</b>		Constituents of shotcrete	29
Absorption water	53	Contamination of batching water	33, 90
Acceleration reaction	40	Coring	96
Accelerator	38	<b>D</b>	
Additives	33	Definition of shotcrete by material	51
Adhesion	25, 44, 77	Definition of shotcrete by process	67
Admixture effects	44	Dense flow process	69
Admixtures	36, 44	Drill cores	96
AF accelerator		Dry sprayed shotcrete	64
(chemical mode of action)	40	Durability	27, 34
Aggregates	29, 56	Dust and rebound	24, 54, 85
alkali-free Accelerator	38, 42, 44	<b>E</b>	
alkaline Accelerator	43, 44	Early strength	26, 93
Alkalinity	39	Earth-moist shotcrete	66
Application	75, 78	EHS in shotcret	75
Application fields	13	EN standards	103
ASTM standards	104	Energy absorption	27, 48, 97
<b>B</b>		Equipment, dense flow process	70
Base mix properties	63	Equipment, thin flow process	73
Base mix requirements	22	Excavation stabilization	13
Batching water	53, 61	Excess water	61
Bonding to substrate	25	<b>F</b>	
<b>C</b>		Fibers	46
Calcined clays	34	Filler	35, 36
Cement	30	Final compressive strength	26, 94
Chemical resistance	27	Fines content, wet	58
Classification of shotcrete by material	51	Fire resistance	28, 46
Classification of shotcrete by process	67	Flowability	23
Cohesion	59	Fly ash	34
Compaction	26	Fresh concrete properties	37, 38, 45, 63
Compressive strength	26, 93, 97	Frost/freeze thaw resistance	28
Compressive strength, initial	26, 95	Fuller curve	56
Concrete pump	70		
Constituent effects	62, 80		

<b>G</b>		Moisture content (dry)	64, 66	<b>S</b>		<b>U</b>	
GGBFS / slag	34	Moisture (aggregates)	53	Safety	75	Uses of shotcrete	13
Grading	56	Monitoring of shotcrete	94	Sand	30	<b>V</b>	
Guidelines	105	<b>N</b>		Saturated surface dry	53	van 't Hoff's rule	41
Gunite	64	Needle penetration method	95	Shotcrete admixtures	36, 44	Viscosity	23
<b>H</b>		Non-reactive additives	36	Shotcrete components	29	<b>W</b>	
Health and safety	75	Norms	103	Shotcrete materials		w/b-ratio	61
Hilti testing	96	Nozzle configuration	82	(definition of shotcrete)	51	w/c-ratio	61
Hydration	31, 40, 61	Nozzleman certification	91	Shotcrete performance	93	w/c-ratio change through acceleration	42
<b>I</b>		<b>O</b>		Shotcrete properties improvement	62	w/c-ratio impact on SC	41
Initial strength	26, 94	Oven dry / OD	53	Shotcrete parameter		Water	32, 61
Inner lining	16	<b>P</b>		recommendations	80	Water reducer	37
<b>J</b>		Packing density	56	Shotcrete requirements	21	Waterproof shotcrete	18, 27
Initial strength	26, 94	Particle size distribution	56	Shotcrete requirements (base mix)	22	Wet sprayed concrete	52
Inner lining	16	Paste volume (wet)	58	Shotcrete requirements (application)	24	Workability time	23
<b>L</b>		PCE	37	shotcrete requirements (mature)	26	<b>X</b>	
Laboratory testing of shotcrete	97	PCE	37	Shotcrete technologies	51, 67	X-ray diffraction	98
Lamination	86	Penetrometer	95	Sieve curve	56		
Layering	86	Performance of shotcrete	93	Silica fume	34		
Leaching	28	Performance of shotcrete	93	Site testing	92		
Limestone filler	35, 36	Performance troubleshooting	101	Slag/ GGBS	34		
Lining	16	pH of accelerators	39	Softness	37		
Lubrication, internal	59	Piston pump	70	Space filling of aggregates	56		
Lubrication, pumping lines	59	Plasticity	31	Spay shadows (meshes)	86		
<b>M</b>		Polycarboxylate ether	37	Sprayability	24		
Macro fibers	46	Process (definition of shotcrete)	67	Spraying rules (angle, distance)	78		
Material balance, dry shotcrete	65	Pulsment	98	Standards	103		
Material balance, wet shotcrete	54	Pumpability	23, 60	SSD	53		
Materials (components of shotcrete)	29	<b>Q</b>		Stiffening/setting	26, 94		
Materials (definition of shotcrete)	51	QC testing	92, 97	Strength/final strength	26, 95		
Material space calculation, wet	54	Quality management	89	Strength classes (J1 - J3)	93		
Measures for mix design improvement		Quality of application	91	Stud-driving test (Hilti)	96		
(wet)	62	Quality of materials	89	Substrate preparation	77		
Membranes	16	<b>R</b>		Superplasticizer	37		
Micro calcite	35	Reaction (AF accelerated shotcrete)	40	Surface wet	53		
MiniShot testing	98	Reactive additives	33	Sustainability	21		
Mix design optimization	62	Rebound and dust	24, 54, 85	<b>T</b>			
Mix design (dry)	64	Requirements on shotcrete	21	Temperature impact on SC	41		
Mix design (wet)	52	Resistance against chemical attack	27	Testing at the laboratory	97		
Mixing water	61	Retarder	38	Testing on site	92		
		Rotor machine	73	Thin flow process	71		
				Troubleshooting	101		



# FOR MORE SPRAYED CONCRETE INFORMATION



## WE ARE SIKA

Sika is a specialty chemicals company with a leading position in the development and production of systems and products for bonding, sealing, damping, reinforcing and protecting in the building sector and the motor vehicle industry. Sika's product lines feature concrete admixtures, mortars, sealants and adhesives, structural strengthening systems, flooring as well as roofing and waterproofing systems.

Our most current General Sales Conditions shall apply.  
Please consult the most current local Product Data Sheet prior to any use.



**SIKA SERVICES AG**  
Tüffenwies 16  
CH-8048 Zürich  
Switzerland

**Contact**  
Phone +41 58 436 40 40  
[www.sika.com](http://www.sika.com)

**BUILDING TRUST**

