



SOFTWARE MANUAL

10 2015 / 00 / Sika Services AG / Marco Poltera

DESIGN SOFTWARE FOR THE ANCHORFIX RANGE USED FOR
ANCHORS AND REBAR CONNECTIONS

BUILDING TRUST



CONTENTS

3	• START-UP AND REGISTRATION	23	• EXAMPLE WORKFLOW
4	• OPERATION	24	• MATERIAL
4	• MAIN MENU	25	• GEOMETRY
6	• GRAPHIC	27	• CONNECTED PROFILE
6	• CONTROLS	27	• LOAD
7	• SECONDARY NAVIGATION	28	• ANCHOR SELECTION
8	• SOFTWARE UPDATE	29	• PRINT OUT
10	• PRIMARY NAVIGATION	30	• REBAR CALCULATION PROGRAM
11	• MATERIAL	30	• GENERAL
12	• GEOMETRY	31	• MENU AREA
13	• CONNECTED PROFILE	32	• PROJECT INFORMATION
14	• LOAD	33	• SYSTEM: SYSTEM SELECTION
15	• RESULT OVERVIEW	34	• EXISTING REINFORCEMENT
17	• PRINT PREVIEW	36	• NEW REINFORCEMENT
18	• CALCULATION	37	• LOAD
18	• UNITS	38	• RESULTS OVERVIEW
19	• ACI 318	39	• PRINT PREVIEW

START-UP AND REGISTRATION

Select Country and Language

On first commencing the software, you will be prompted to select the country in which you are working and the language you would like the software to be in. These can be selected from the dropdown menus.

Registration

You will be asked to provide basic information in order to register your version of the software:

- Email address
- Your first and last name
- Your company and your position

No statistical data is collected from this information and the data provided is not collected by Sika. It is for registration purposes only.

Once your registration has been accepted, you will receive an email confirming your registration containing your personal registration code. Input this code to complete the registration process. Please be aware that registering the software requires an active internet connection.

Users will not be prompted to register again. The registration code is restricted to one user (using the email account provided) and on one device. Users may request registration on a new device.

Note: you may choose to skip the registration process. This will allow you access to the software for a period of 30 days, after which you must register the software. If the software is not registered after this 30 day period, the user will no longer be able to access the software until they complete the registration process.

Select Software

Select which version of the software you are going to use to perform the design:

- Anchor Design
- Rebar Design*
- Software Update

*Rebar design is according to EOTA TR023 only. It is intended for use with products holding a valid European Technical Assessment to EOTA TR023 and is not intended for use in conjunction with ACI 318-08 or ACI 318-11.

Disclaimer and Privacy Policy

Once you have selected which software type you would like to use you will be presented with a disclaimer and privacy policy.

Read the disclaimer and privacy policy carefully and click “agree” to continue. Otherwise, click “decline” to exit.

OPERATION

MAIN MENU

The user interface consists of five main parts

- Main menu at the top
- Primary navigation beneath the main menu
- Secondary navigation of input fields
- 3D graphic on the right side
- User inputs on the left side

In addition the program is split into six tabs

- Project information
- Material
- Geometry
- Load
- Result overview
- Print preview

The primary navigation allows for direct access to all available tabs whereas the secondary navigation enables convenient navigation to the previous and following tab. It also contains any plausibility messages. Ideally you should work through the tabs from left to right. This will lead you through all relevant input parameters up to the print preview. Note that the print preview is only available after a calculation is performed.

Depending on the currently active tab the user input area will change. Most tabs also feature a 3D graphic which can be used to enter some inputs in a more visual manner. As inputs are made the graphic will change to reflect the inputs.

The main menu is made up of several buttons that allow loading and saving projects as well as calculating the current project.

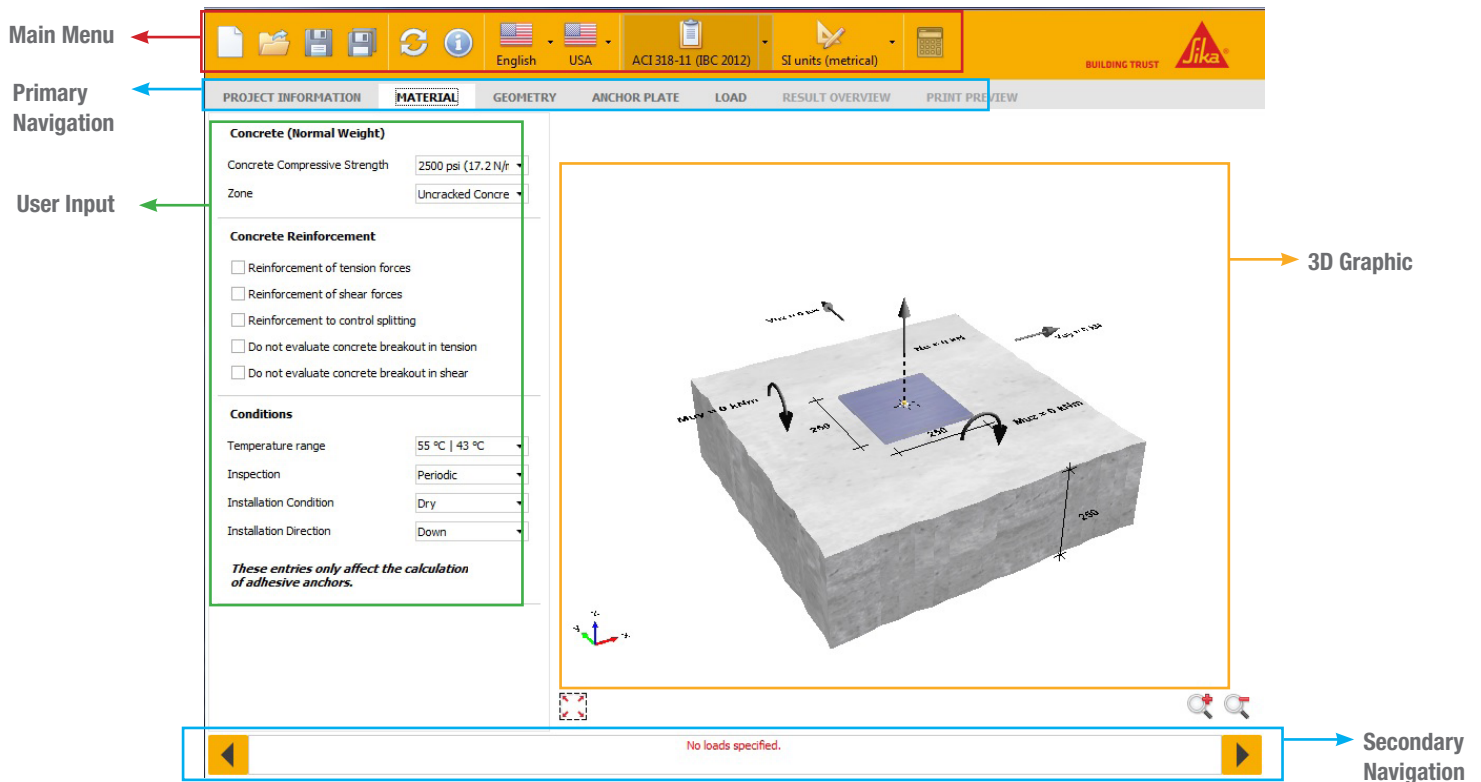

OPERATION

MAIN MENU

The **main menu** is made up of several buttons that allow loading and saving projects as well as calculating the current project.

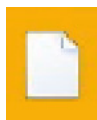
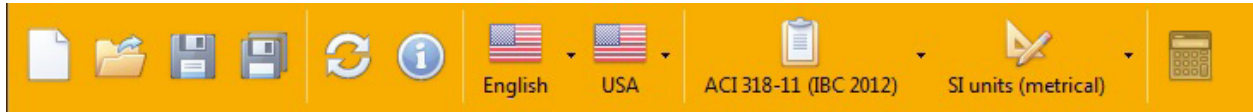

Create a new project and clear previous user inputs and selections.
Warning: Any changes you made to the current project will be lost if you do not save them.

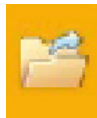

Open an existing project file and load previously saved user inputs.
Warning: Any changes you made to the current project will be lost if you do not save them.

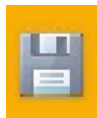

Save the current project in a file.
If a new project is saved for the first time you will be prompted to select a storage location and enter a file name. If the storage location and file name was set previously you will not be prompted again.



Save the current project in a file and select the storage location and file name.
Hint: Use this function to make a copy of an existing project file.



Show the update tool.
Use the update tool to manually check for updates or configure automatic updates. See the update section for more details.



Show information about the Anchor Calculation software. It contains contact and version information.

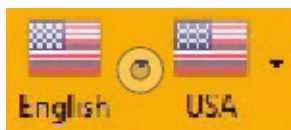

Selecting the flag of the country relevant to the user ensures that the software is calculating and offering solutions relevant to the location of the software user. Selecting the relevant country also allows for the appropriate selection of languages to be available to the user.

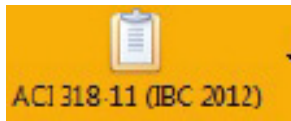

Select the relevant design code for the anchor design. The selection can be toggled between: EOTA TR029, ACI 318-08 (IBC 2009) and ACI 318-11 (IBC 2012).

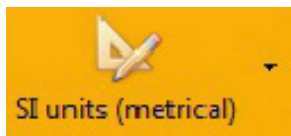

Select your preferred system of measurement. Choose between U.S. customary units and SI units (metric). See the units section for more details.



Calculate all selected anchors.
This button may be disabled if there are plausibility messages that prevent a calculation.

OPERATION

GRAPHIC

The 3D graphic is a visual aid built from all current user inputs. The graphic is independent of the currently active tab and will be shown for the material, geometry and load tabs. It is part of the final print out as well.

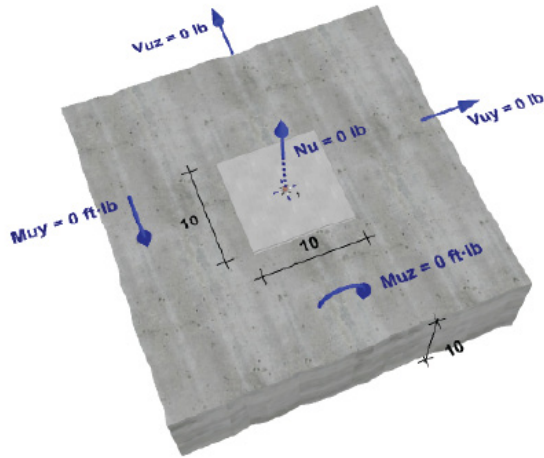

The following properties can be changed directly using the graphic

- Anchor spacing
- Edge distance
- Concrete thickness
- Anchor plate dimensions
- Loads

Tooltip

A tooltip containing the property's name and unit will appear if you hover your mouse over any number in the graphic. To change a property using the graphic click on a number. A new input field will prompt you for the new value. Press the enter key to confirm it. In addition you can enable and disable edges by clicking on the corresponding concrete edge in the graphic.

CONTROLS

The graphic can be controlled by the buttons underneath it as well as with the mouse.



Reset the graphic's rotation and zoom to default values.



Zoom in to get a closer look on details.
Keep this button pressed to continue zooming



Zoom out to get a better overview
Keep this button pressed to continue zooming.



Pan

Move the graphic in a vertical and/or horizontal direction by pressing and holding the left mouse button followed by moving the mouse. Release the left mouse button to stop moving the graphic.



Rotate

Rotate the graphic around its center by pressing and holding the the right mouse button followed by moving the mouse. Release the right mouse button to stop rotating the graphic.



Zoom

Zoom in by scrolling the mouse wheel up. Zoom out by scrolling the mouse wheel down.

OPERATION

SECONDARY NAVIGATION

The secondary navigation enables convenient navigation to the previous and following tab. It also contains any plausibility messages.



MESSAGES

Every time user inputs are changed a plausibility check will be performed. If any errors are encountered they will be displayed in the secondary navigation's message area in red.

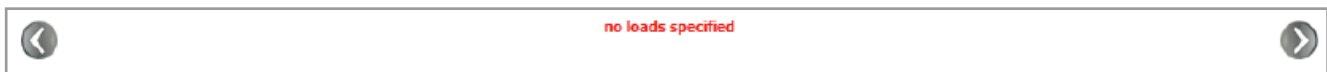

All plausibility messages have to be resolved before the project can be calculated. The calculation then performs another plausibility check for each anchor. Since anchors differ in their properties there may be plausibility messages for some anchors but not for others. Any plausibility messages for the currently selected anchor will also be displayed in the secondary navigation's message area. See the calculation result topic for more details on per anchor plausibilities.

List of possible plausibility messages

Message	Explanation	Possible Resolutions
The member thickness has to be larger than ...	The concrete member is too thin	Increase the concrete thickness.
The edge distance on the left hand side has to be equal to or larger than ...	The left edge distance is too low.	Increase the left edge distance or select another anchor. Make sure the anchor plate is completely on the concrete.
The edge distance on the right hand side has to be equal to or larger than ...	The right edge distance is too low.	Increase the right edge distance or select another anchor. Make sure the anchor plate is completely on the concrete.
The edge distance on the upper side has to be equal to or larger than ...	The top edge distance is too low.	Increase the top edge distance or select another anchor. Make sure the anchor plate is completely on the concrete.
The edge distance on the lower side has to be equal to or larger than ...	The bottom edge distance is too low.	Increase the bottom edge distance or select another anchor. Make sure the anchor plate is completely on the concrete.
Anchor outside of anchor plate	Anchors have to be within the anchor plate.	Reduce anchor spacing or increase anchor plate dimensions and check the eccentricity.
no loads specified	The calculation is only possible if at least one load is defined.	Define at least one load.
The selected installation condition is not valid for this anchor	Some adhesive anchors are not approved for certain installation conditions.	Change the installation condition or select another anchor.
The selected temperature range is not valid for this anchor	Some adhesive anchors are not approved for certain temperature ranges.	Change the temperature range or select another anchor.
The selected seismic category is not valid for this anchor	Some anchors are not approved for seismic risk.	Disable seismic risk or select another anchor.
The selected installation direction is not valid for this anchor	Some anchors are not approved for overhead or wall installations.	Change the installation direction or select another anchor.
invalid edge distance	One of the current edge distances is less than the selected anchor's minimum edge distance.	Increase the lowest edge distance or select another anchor.
invalid spacing distance	One of the current anchor spacings is less than the selected anchor's minimum spacing.	Increase the lowest anchor spacing or select another anchor.
invalid member thickness	The current concrete thickness is less than the selected anchor's minimum concrete thickness.	Increase the concrete thickness or select another anchor.

OPERATION

SOFTWARE UPDATE

The Live Update will keep your Sika Anchor Calculation software up to date automatically.

By default the update tool will automatically look for updates every seven days. If updates are available the new files will be downloaded automatically in the background. When you start or exit the software and updates are ready to be installed you will see the following prompt. Click Yes to install the update now. Click No to continue working normally. You will be prompted again at a later time. Since updates do not require administrative privileges you can perform updates at any time without involving your system administrator.

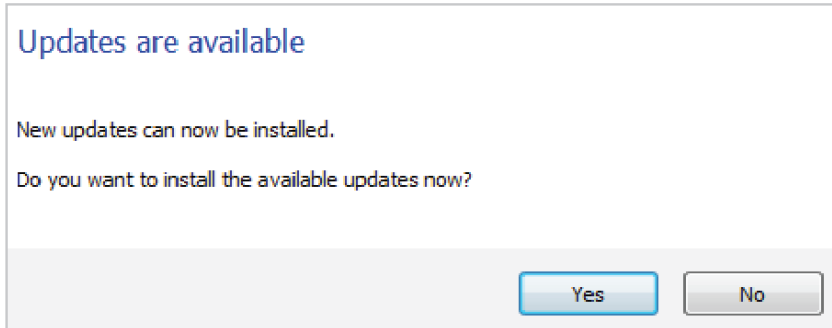

Generally you won't have to access the update tool by yourself because everything happens automatically. If you would like to check for updates manually, change the update settings or just see the current status however you can launch the update tool from the software's main menu.

The following information is available from the update's main window:

- Date you last searched for an update
- Date you last installed an update
- Status of automatic updates (enabled or disabled)

To access the options menu click on the Options link.

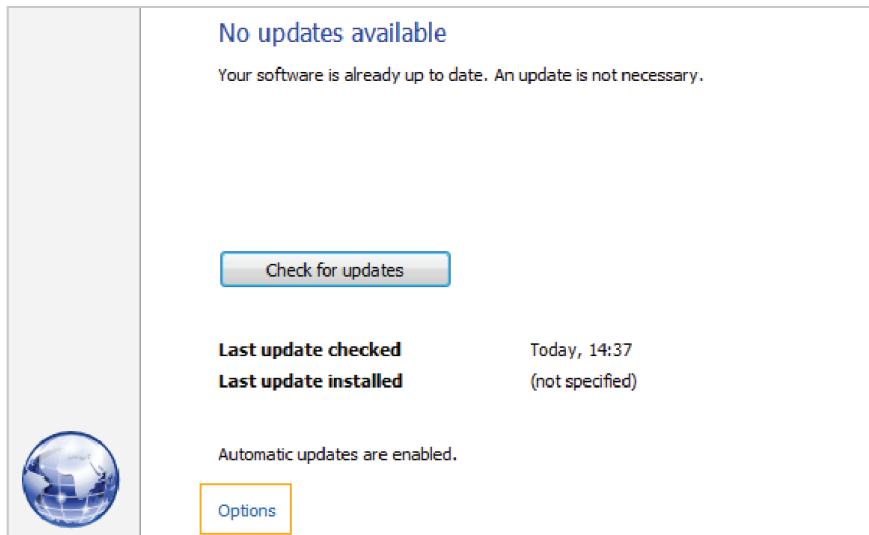

OPERATION

SOFTWARE UPDATE

The options menu is split in two tabs: General and Proxy.
The **General tab** contains configuration options for the update's behavior.

When to check for updates

- Manually
- Automatically on program launch
- Automatically on system launch.

How often to check for updates

- Every time
- Daily
- Weekly.
- Monthly

When to show the notification tray icon

- Always
- When an update is in progress
- When user interaction is required
- In case an error occurred
- Never

When to download updates

- Manually
- Automatically (only while program is active)
- Automatically (always)

When to prompt for update installation

- On system launch
- On program launch
- On program termination
- As soon as available

The screenshot shows the 'General' tab of a settings dialog. It has two tabs: 'General' and 'Proxy'. The 'General' tab is active. The settings are as follows:

- Look for updates: Automatically at system launch
- Frequency: Weekly
- Download updates: Automatically (always)
- Install updates: On request at system launch, On request at program launch, On request at program termination, On request (once available)
- Autostart: Start automatically when Windows is being launched
- Show notification tray icon: When user interaction is required

At the bottom right, there are 'OK' and 'Cancel' buttons.

The screenshot shows the 'Proxy' tab of the same settings dialog. The 'General' tab is also visible. The settings are as follows:

- Use proxy
- Address: [text input field]
- Port: 0
- Use proxy authentication
- User name: [text input field]
- Password: [text input field]

At the bottom right, there are 'OK' and 'Cancel' buttons.

The Proxy tab contains proxy server configuration options. Generally you won't have to edit anything here. The update tool will try to detect the correct proxy settings automatically. If the update is unable to establish a connection to the internet you may have to manually configure the proxy options. In this case please contact your system administrator. They will know the correct proxy settings.

OPERATION

PRIMARY NAVIGATION

The primary navigation allows direct access to all available tabs

- Project information
- Material
- Geometry
- Load
- Result overview
- Print preview

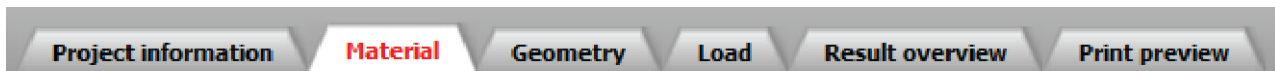

PROJECT INFORMATION

The project information tab contains additional details about the project that do not influence the calculation.

▶ Project

Name	<input type="text"/>
Number	<input type="text"/>
Object	<input type="text"/>
Deadline	<input type="text" value="15/04/2014"/>
Comments	<input type="text"/>

General project information

- Project name
- Project number or code
- Deadline

▶ Constructor

Name	<input type="text"/>
Contact	<input type="text"/>
Address	<input type="text"/>
Telephone	<input type="text"/>
Fax	<input type="text"/>
Email	<input type="text"/>

Contractor, Sub-Contractor & Engineer

- Name of the company or person
- Name of the contact person
- Address
- Telephone number
- Fax number
- E-mail address

Other notes related to the project can be added to the comments field. Examples include assumptions, hints and calculation requirements.

▶ Comments

OPERATION

MATERIAL

The material tab deals with concrete, reinforcement and additional condition properties.

► Concrete

Concrete class	2500 psi	▼
Zone	non cracked concrete	▼

Concrete class

Select how much compressive strength the concrete can withstand. Anchor performance data may change depending on the concrete's compressive strength with higher values usually leading to higher capacities.

Zone

Select if the anchoring will be performed in cracked or uncracked concrete. While uncracked concrete leads to higher capacities it requires the concrete meets certain conditions which usually means further analysis has to be performed by the designer.

► Reinforcement

<input type="checkbox"/>	Reinforcement of axial forces
<input type="checkbox"/>	Reinforcement of lateral forces
<input type="checkbox"/>	Enclosed in stirrups with distance of no more than 4 inches

Reinforcement of axial forces

Select this option if "Condition A" for axial forces applies to the concrete in the area surrounding the anchorage as defined by ACI 318. Condition A usually applies if there is supplementary reinforcement to control splitting. This option influences the concrete breakout and pryout proofs. If this option is not selected "Condition B" is assumed and the calculation is carried out as if there was no reinforcement against axial forces.

Reinforcement of Lateral forces

Select this option if "Condition A" for Lateral forces applies to the concrete in the area surrounding the anchorage as defined by ACI 318. Condition A usually applies if there is an edge reinforcement with at least a #4 bar. Condition A may improve concrete edge failure capacity by up to 20%. If this option is not selected "Condition B" is assumed and the calculation is carried out as if there were no reinforcement against lateral forces.

Enclosed stirrups with distance \leq 4 inches

This option may be selected in addition to "Reinforcement of shear forces" if the edge reinforcement is enclosed within stirrups spaced at not more than 4 inches. This will improve concrete edge failure capacity.

► Conditions

Temperature range	110°F 68°F	▼
Inspection	Continuous	▼
Conditioning	Dry	▼

Temperature range

A temperature range is defined by a maximum short term temperature (first value) and a maximum long term temperature (second value). Anchor performance data may change depending on the selected temperature range. Some anchors may not be suitable for use in certain temperature ranges.

Inspection

Select whether continuous or periodic inspection is performed. This option influences the bond strength proof. (Not relevant to European Technical Assessments or for design according to EOTA TR029)

The following values are available

- Continuous
- Periodic

OPERATION

MATERIAL

Installation conditions

Select the condition the drill holes will be in during the anchor's installation. This option influences the bond strength proof. Some anchors may not be suitable for certain installation conditions.

The following values are available

- Dry
- Water-saturated
- Water-filled
- Submerged (Not included in European Technical Assessments).

GEOMETRY

The geometry tab deals with anchor arrangements, concrete dimensions and anchor plate dimensions.

Anchor

Single Anchor without slotted hole

Eccentricity

y 0.000 inch z 0.000 inch

Angle 0°

Anchor arrangement

Select either a single anchor or a group of two, three, four, six or eight anchors to define the general anchor arrangement. Some arrangement feature variants with slotted holes.

Slotted holes

The software offers the possibility to allocate slotted holes to one or more anchors. They allow more flexibility during the installation. Using this option you can influence which anchors will transmit shear forces. Usually base plates have slotted holes in order to assign all tension forces to certain anchors and all shear forces to the remaining anchors. Another application is anchoring near the concrete edge. With slotted holes near the edge you can prevent anchors from bearing shear forces directed towards the edge which may lead to a lower utilization capacity regarding concrete edge failure.

Not all anchor arrangements allow for slotted holes and even if they do not every anchor can be allocated a slotted hole. The program limits slotted hole combinations to sensible variants.

OPERATION

GEOMETRY

Eccentricity of anchor plate

Defines an offset between the anchor group's center and the anchor plate's center allowing you to change the anchor's positions on the anchor plate through y and z coordinates. This may lead to increased load which is taken into account by the software automatically. If you move anchors outside of the anchor plate you will see a plausibility message.

The default values $y = 0$ and $z = 0$ mean the anchor groups's center is the same as the anchor plate's center.

Anchor spacing

Defines the distance between anchors. Depending on the selected anchor arrangement there may be up to four different spacing values or non at all for a single anchor. Please note that y represents horizontal spacing and z represents vertical spacing. Lower spacing values usually lead to higher anchor utilization with smaller design actions. Please be aware that an anchor's Evaluation report may define minimal anchor spacings. If you go below these values the anchor in question cannot be calculated and you will see a plausibility message.

Angle

The anchor arrangement may be rotated around its center in steps of 90° . Slotted holes will be rotated as well. Use this option to gain access to additional variations of the selected anchor arrangement.

▶ Edge distances / member thickness

<input type="checkbox"/> Edge left	
<input type="checkbox"/> Edge right	
<input type="checkbox"/> Edge top	
<input type="checkbox"/> Edge bottom	
Member thickness	10.000 inch

Edge distances

Defines which (if any) concrete edges have to be taken into consideration and what their respective edge distances are. By default the software assumes there are no relevant concrete edges. Click a check box on the left side to enable or disable a specific edge. You will be able define edge distances for enabled edges on the right side. Please note that the edge distance is defined as the distance from the concrete edge to the nearest anchor and not the distance to the nearest edge of the anchor plate. Smaller edge distances usually lead to higher anchor utilization with smaller design actions. An anchor's evaluation report may require a minimum edge distance that depends on the anchor's diameter and embedment depth. If one of the current edge distances is too low for the selected anchor you will see a plausibility message.

Concrete thickness

Defines the concrete member's thickness. An anchor's evaluation report may require a minimum concrete thickness that depends on the anchor's diameter and embedment depth. If the current concrete thickness is too low for the selected anchor you will see a plausibility message.

▶ Anchor plate dimensions

Width of baseplate	y	10.000 inch
Length of baseplate	z	10.000 inch
Fixture thickness		0.400 inch

It is assumed the anchor plate will be rectangular. Therefore its geometry can be defined by the anchor plate width, length (height) and thickness.

The anchor plate width and length will be used for plausibility tests concerning anchor arrangement and edge distances. Anchors have to be within the anchor plate and the anchor plate has to be completely on concrete.

OPERATION

LOAD

▶ Load

Axial force	N_x <input type="text" value="0 lb"/>
Lateral forces	V_{uy} <input type="text" value="0 lb"/>
	V_{uz} <input type="text" value="0 lb"/>
Torques	M_{uy} <input type="text" value="0 ft·lb"/>
	M_{uz} <input type="text" value="0 ft·lb"/>
Shear load conditions	
<input type="checkbox"/> Use anchors with built-up grout pads	

The user is expected to input design loads. Design loads (also known as factored loads) may be obtained by calculating specific load combinations (live loads, dead loads, ...). Please note that the software cannot calculate these load combinations. You will only be able to input loads and moments that can be absorbed by the selected anchor arrangement.

Axial force

Specify a load that acts perpendicular to the anchor plate along the x axis. Use positive values for tension ("pulling" upwards) and negative values for compression ("pushing" downwards). The 3D graphic displays arrows to indicate load direction.

Lateral forces

Specify loads that act parallel to the anchor plate. Use positive y values for forces that act from left to right along the y axis. Use positive z values for forces that act from bottom to top along the z axis. Use negative values to reverse the directions. The 3D graphic displays arrows to indicate load direction.

Torques

Specify a torsional moment that acts around the x axis and bending moments that act around the y and z axis. Use positive values for moments acting counterclockwise and negative values for moments acting clockwise. The 3D graphic displays arrows to indicate moment direction.

Shear load conditions

If anchors are used with built-up grout pads the nominal shear strength shall be multiplied by a 0.80 factor according to ACI 318 Appendix D.6.1.3. Select this option to allow the software to modify the calculations accordingly. This does not affect designs according to EOTA TR029.

Select which load combination method was used to calculate the design loads. The software will take the corresponding strength reduction factors and resistance modification factors into account.

The following values are available

- ACI 318 Chapter 9.2
- ACI 318 Appendix C

ACI 318 Chapter 9.2 ("Strength and serviceability requirements - Required strength") defines formulas to combine different load types (e.g. live loads, dead loads, wind loads, ...) using load factors. This method was adapted from SEI/ASCE 7-02 (Structural Engineering Institute / American Society of Civil Engineers 7: Minimum Design Loads for Buildings and Other Structures) in 2002 to unify load factors and combinations.

The old ACI 318 load factors and combinations from 1999 were revised and moved to ACI 318 Appendix C. They have evolved since the early 1960s and are considered to be reliable for concrete construction. If Appendix C is used it replaces the contents of Chapter 9.2 and 9.3. The load combination method defined in ACI 318 Appendix C.9.2 ("Alternative load and strength reduction factors - Required strength") defines a similar method to Chapter 9.2 but is using other combination formulas and other load factors.

For combinations with lateral loads, some designs will be different, but the results of either load combination method are considered acceptable. More details may be found in the actual ACI 318 code.

For designs according to EOTA TR029, the combinations of dead and live loads inputted must take into consideration additional partial safety factors to account for the loading case.

▶ Load combination

ACI 318 chapter 9.2	▼
<input type="checkbox"/> Moderate to high seismic danger	

OPERATION

RESULT OVERVIEW

Filter

Threaded rod
 Rebar
 Diameter unit: U.S. Unit (inch)

Filter

By default all available anchors are calculated every time you click the Calculate button. The filter section allows you to focus on anchors with specific criteria. This speeds up the calculation and makes it easier to find the anchors you are interested in.

Anchors may either be used to anchor a threaded rod or a reinforcement bar (rebar). Most anchors will be available in a fractional diameter (like 1/2 inch) but some may also be available with a metric thread (like M12).

Anchor list

The anchor list shows all anchors that conform to the selected filter criteria.

Name	Steel	Diamete	hef
AnchorFix-3001	Carbon A36	3/8"	2 3/8" -
AnchorFix-3001	Carbon A36	1/2"	2 3/4" -
AnchorFix-3001	Carbon A36	5/8"	3 1/8" -
AnchorFix-3001	Carbon A36	3/4"	3 3/4" -
AnchorFix-3001	Carbon A36	7/8"	4" - 17
AnchorFix-3001	Carbon A36	1"	4" - 20"
AnchorFix-3001	Carbon A36	1 1/4"	5" - 25"
AnchorFix-3001	Carbon A193 B7	3/8"	2 3/8" -
AnchorFix-3001	Carbon A193 B7	1/2"	2 3/4" -
AnchorFix-3001	Carbon A193 B7	5/8"	3 1/8" -

Anchors can be sorted by name, material (steel), diameter and effective embedment depth (hef) by clicking on the corresponding table header.

Name	Steel	Diamete	hef
AnchorFix-3001	(All)	3/8"	2 3/8" -
AnchorFix-3001	<input type="checkbox"/> Carbon A193 B7	1/2"	2 3/4" -
AnchorFix-3001	<input type="checkbox"/> Carbon A307 A	5/8"	3 1/8" -
AnchorFix-3001	<input type="checkbox"/> Carbon A36	3/4"	3 3/4" -
AnchorFix-3001	<input type="checkbox"/> Carbon A615-40	7/8"	4" - 17
AnchorFix-3001	<input type="checkbox"/> Carbon A615-60	1"	4" - 20"
AnchorFix-3001	<input type="checkbox"/> Stainless F593 CW	1 1/4"	5" - 25"
AnchorFix-3001	<input type="checkbox"/> Stainless F593 SH	5/16"	2 3/8" -
AnchorFix-2	Carbon A193 B7	3/8"	2 3/8" -
AnchorFix-2	Carbon A193 B7	1/2"	2 3/4" -
AnchorFix-2	Carbon A193 B7	5/8"	3 1/8" -
AnchorFix-2	Carbon A193 B7	3/4"	3 1/2" -

The anchor list can be filtered further by clicking the little filter icon in the table headers. You can select multiple values per filter and multiple filters can be active at the same time.

Anchor details

Below the anchor list you will see details for the currently selected anchor including a product picture and additional documents like the product data sheet from the catalog, a flyer / brochure to introduce the product.

Anchor



 Product data sheet

 Safety data sheet

 Approval

Click on a button to open the corresponding PDF document or link to the appropriate data.

OPERATION

RESULT OVERVIEW

Result list

All results are shown in a table which includes details about the anchor, its percentage utilization and suitability.

Name ▲	Steel ▲	Diameter ▲	hef ▲	Total capacity ▲	Results ▲
AnchorFix-3001	Carbon A615-40	#7	4"	86.91 %	Anchor acceptable
AnchorFix-3001	Carbon A615-60	#7	4"	86.91 %	Anchor acceptable
AnchorFix-3001	Stainless F593 CW	7/8"	4"	86.91 %	Anchor acceptable
AnchorFix-3001	Stainless F593 SH	7/8"	4"	86.91 %	Anchor acceptable
AnchorFix-3001	Carbon A193 B7	1"	4"	86.91 %	Anchor acceptable
AnchorFix-3001	Carbon A36	1"	4"	86.91 %	Anchor acceptable
AnchorFix-3001	Carbon A615-40	#8	4"	86.91 %	Anchor acceptable
AnchorFix-3001	Carbon A615-60	#8	4"	86.91 %	Anchor acceptable
AnchorFix-3001	Stainless F593 CW	1"	4"	86.91 %	Anchor acceptable
AnchorFix-3001	Stainless F593 SH	1"	4"	86.91 %	Anchor acceptable
AnchorFix-3001	Carbon A193 B7	1 1/4"	5"	71.39 %	Anchor acceptable
AnchorFix-3001	Carbon A36	1 1/4"	5"	71.39 %	Anchor acceptable
AnchorFix-3001	Carbon A615-40	#10	5"	71.39 %	Anchor acceptable
AnchorFix-3001	Carbon A615-60	#10	5"	71.39 %	Anchor acceptable
AnchorFix-3001	Stainless F593 CW	1 1/4"	5"	71.39 %	Anchor acceptable
AnchorFix-3001	Stainless F593 SH	1 1/4"	5"	71.39 %	Anchor acceptable
AnchorFix-3001	Stainless F593 SH	3/8"	7 1/2"	104.36 %	Anchor overloaded
AnchorFix-2	Carbon A307 A	1/2"	6"	114.96 %	Anchor overloaded

Anchors can be sorted by name, material (steel), diameter, effective embedment depth (hef) and utilization by clicking on the corresponding table header. By default they are sorted by utilization.

Utilization is given by a percentage value and a color coded bar where green means acceptable and red means overloaded. Some anchors may not have a utilization value because they are not applicable for the parameters you entered. The results column shows a short color coded text to describe whether the selected anchor is acceptable, overloaded or not applicable. Select an anchor to see more details about the calculation. If the selected anchor is not applicable the reason(s) will be shown in the message area.

Anchor	Nu	Vu
1	2500 lb	2500 lb
2	2500 lb	2500 lb
3	2500 lb	2500 lb
4	2500 lb	2500 lb

Resulting forces

Below the result list you will see the resulting forces for the selected solution. For every anchor in the arrangement the tension load Nu and the combined shear load (y + z axis) Vu is displayed.

Proof	Total capacity	Results
Steel failure	11.80 %	✓
Concrete failure	81.52 %	✓
Bond strength	52.94 %	✓
Steel failure - shear force	22.69 %	✓
Pryout	37.85 %	✓
Concrete edge failure	0.00 %	✓
Interaction	99.48 %	✓

Calculation details

Next to the resulting forces you will see calculation details in the form of a breakdown by failure mode (proof).

The breakdown includes the allowed capacity and the actual utilization per proof. Utilization is given by a percentage value and a color coded bar where green means acceptable and red means overloaded. Additionally acceptable proofs are marked with a green tick whereas overloaded proofs are marked with a red cross. The controlling failure mode is the one with the highest utilization. Some proofs do not have a meaningful capacity value. A proof with the capacity 0 lb and utilization 0 % was not performed because the anchor's evaluation report defined it to not be controlling.

OPERATION

PRINT PREVIEW

The print preview tab shows a report containing all user inputs and calculation results as well as information about the selected anchor. You can print the report or save it as a PDF file. The print preview tab is only accessible after pressing the calculate button to calculate the current project.

The screenshot shows the print preview interface. On the left is a sidebar with the following sections:

- Print preview:** Contains icons for saving as PDF and printing.
- Page:** Includes zoom in (+), zoom out (-), zoom level (100), and page navigation (first, previous, current page 1, next, last).
- Date:** Has radio buttons for 'without', 'Date', and 'Selected date'. The 'Date' option is selected, and a date field shows '22/04/2014'.
- Print options:** Has a checked checkbox for 'Print project data' and a 'Picture resolution' field set to '100'.

The main report area on the right displays:

- Project information: Project number, Contact (simonk), Version (0.9.4.3), and Date (22/04/2014). Logos for BUILDING TRUST and Sika are present.
- Section title: **Anchor calculation Sika AnchorFix-3001 - Carbon A193 B7 5/8"**
- Section: **Product information**
- Item: **Sika AnchorFix-3001 - Carbon A193 B7 5/8"**
- Table of properties:

Material	Carbon A193 B7
Type	Adhesive anchor
Approval	Sika AnchorFix-3001 ESR-3608
Drill hole depth	3 3/8"
Nominal drill bit diameter	3/4"
effective anchorage depth	3 3/8"
Recognized code	2009 IBC
- Image of the Sika AnchorFix adhesive cartridge.
- Section: **Material**
- Table of material properties:

Concrete	
Concrete class	2500 psi
Zone	non cracked concrete

There are multiple buttons on the left side of the actual print preview. They allow you to control and configure the print out.

This block shows a close-up of the sidebar controls:

- Print preview:** Save report as a PDF file (PDF icon) and Print the report (Printer icon).
- Page:** Zoom in (+), zoom out (-), zoom level (100), and page navigation (first, previous, current page 1, next, last).

The page and zoom buttons control which part of the print out will be visible in the preview area.

This block shows a close-up of the page navigation buttons: first, previous, current page 1, next, last.

Zoom

- Show the whole page in the print preview area.
- Show the full page width in the print preview area.
- Show the print out in its actual size (100%).

Page

- Go to the first page.
- Go to the previous page.
- Displays the current page number and number of total pages. Type in a page number to go directly to this page.
- Go to the next page.
- Go to the last page.

By default the current date will be shown in the print out's header. You can specify a date which should be shown instead or you may opt to not show a date at all.

This block shows a close-up of the Date selection controls:

- Radio buttons for 'without', 'Date', and 'Selected date'. 'Date' is selected.
- A date field showing '22/04/2014'.

Any project information you have entered will be part of the print out by default. If you wish to exclude the project information uncheck the box below.

This block shows a close-up of the Print options controls:

- Checked checkbox for 'Print project data'.
- 'Picture resolution' field set to '100'.

CALCULATION

UNITS

The software supports U.S. customary units and SI (metric) units. The currently selected system of measurement is visible in the main menu at any time. It affects all user inputs, the calculation and the printout.

U.S. customary units

Conversion from U.S. customary units to SI units

U.S. customary units	SI units (metric)
1 inch	25.4 mm
1 inch ²	645.16 mm ²
1 psi	0.00689 MPa (N/mm ²)
1 lb	4.45 N
1 ft*lb	1.36 * 10 ³ kNm

SI units (metrical)

Conversion from SI units to U.S. customary units

U.S. customary units	SI units (metric)
1 mm	0.039 inch
1 mm ²	1.55 * 10 ³ inch ²
1 MPa (N/mm ²)	145 psi
1 N	0.22 lb
1 kNm	737.56 ft*lb

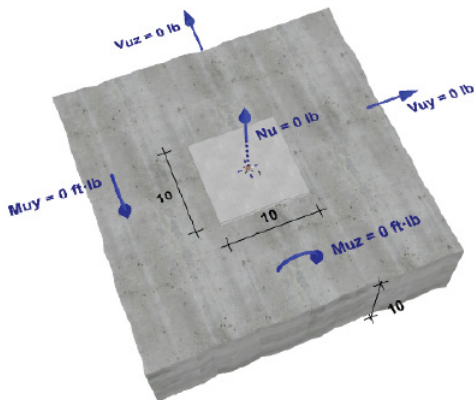

Design loads

The user is expected to input design loads. Design loads (also known as factored loads) may be obtained by calculating specific load combinations (live loads, dead loads, ...). Please note that the software cannot calculate these load combinations.

CALCULATION

ACI 318

The calculation is carried out in accordance with ACI 318 Appendix D and specific anchor's evaluation reports. ACI 318 defines nine different proofs for anchor calculations. Six of them relate to tension and three of them relate to shear. Depending on an anchor's evaluation report not all proofs have to be performed. In case of a seismic calculation some proofs are modified in accordance with ACI 318 and the anchor's evaluation report.

Steel Failure (Tension)

- Steel proof
- Verification of adequate steel rod diameter

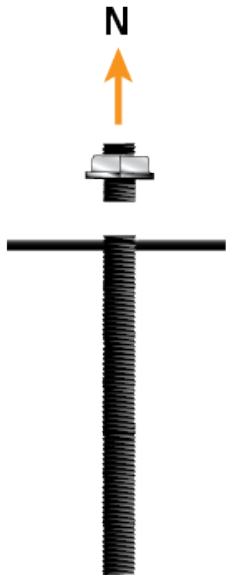

Concrete Breakout (Tension)

- Concrete proof
- Influenced by concrete compressive strength and concrete reinforcement.
- Verification of adequate load bearing capacity of the concrete member in order to prevent the breakout of a concrete cone.

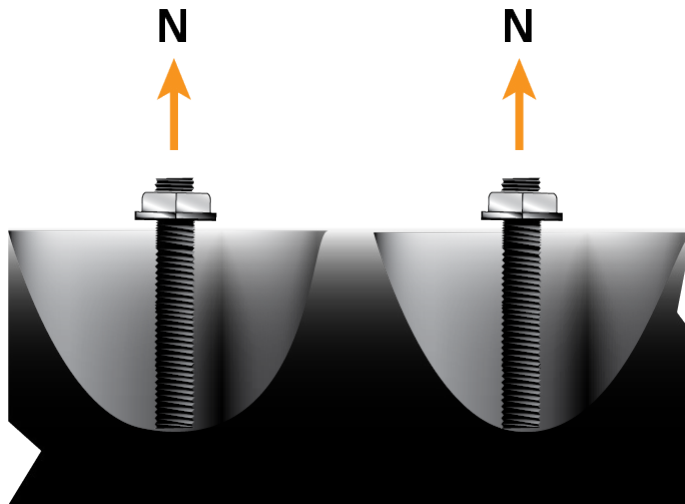

CALCULATION

Concrete Splitting (Tension)

- Concrete proof
- Influenced by concrete compressive strength, concrete reinforcement and geometry
- Verification that splitting does not occur, especially in thin concrete members

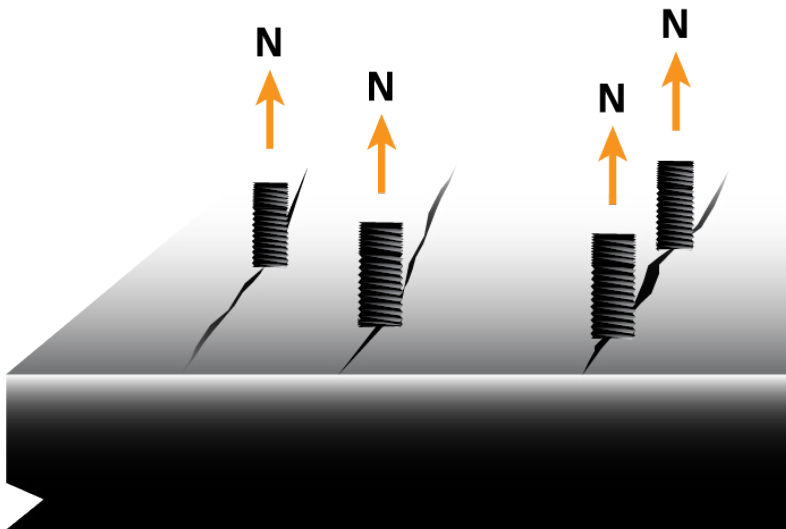

Bond Failure (Tension)

- Mortar proof
- Influenced by concrete compressive strength, concrete reinforcement and conditions
- Verification of adequate bond in the mortar between threaded rod or rebar and concrete

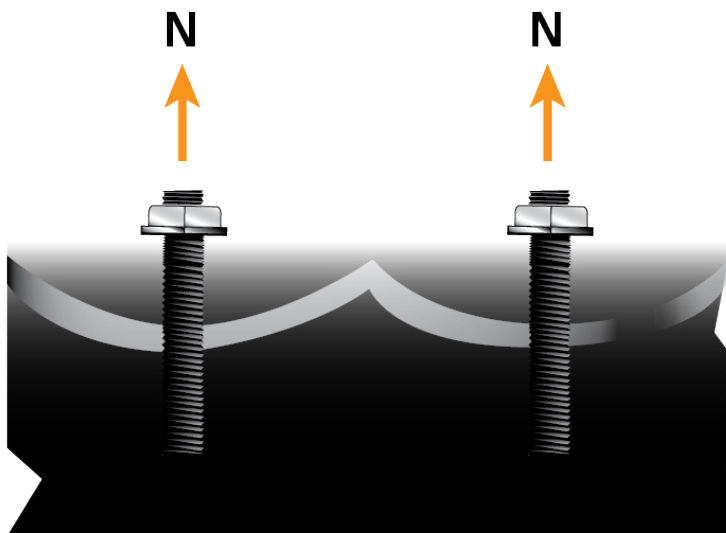

CALCULATION

Steel Failure (Shear)

- Steel proof
- Verification of adequate shearing resistance within the steel diameter of the threaded rod or rebar

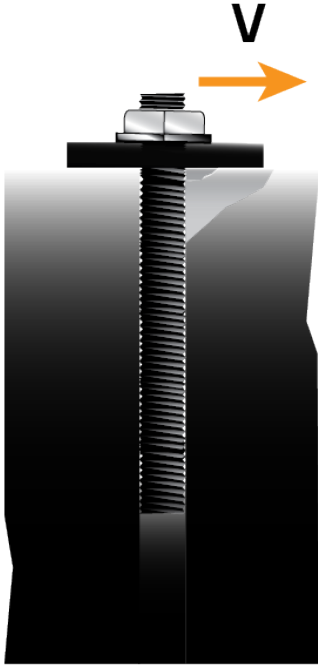

Concrete Pryout (Shear)

- Concrete proof
- Influenced by concrete compressive strength and concrete reinforcement
- Verification of adequate load bearing capacity of the concrete member on the non-load side to prevent break-out of a concrete cone

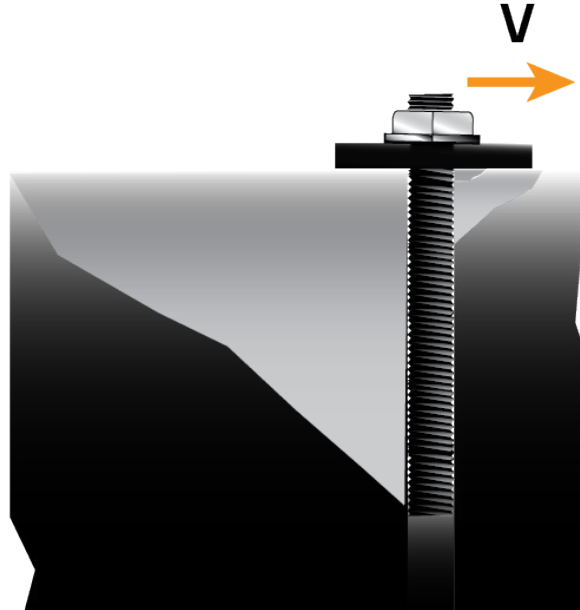

Concrete Breakout (Shear)

- Concrete proof
- Influenced by concrete compressive strength and concrete reinforcement
- Verification of adequate load bearing capacity at the edge in order to prevent concrete edge failure

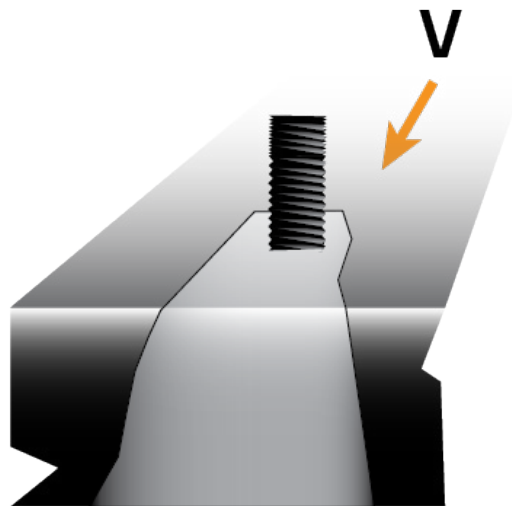
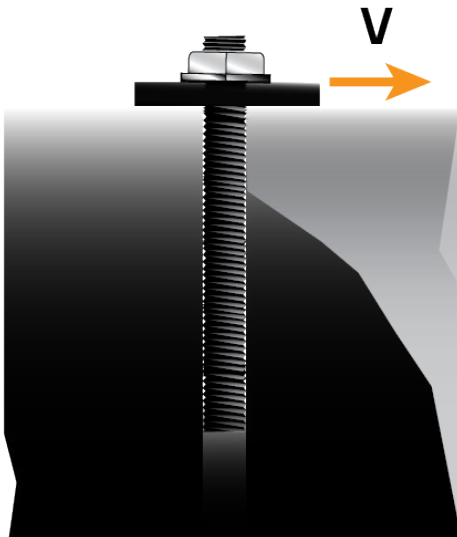

CALCULATION

Concrete Breakout (Shear)

- Concrete proof
- Influenced by concrete compressive strength and concrete reinforcement
- Verification of adequate load bearing capacity at the edge in order to prevent concrete edge failure

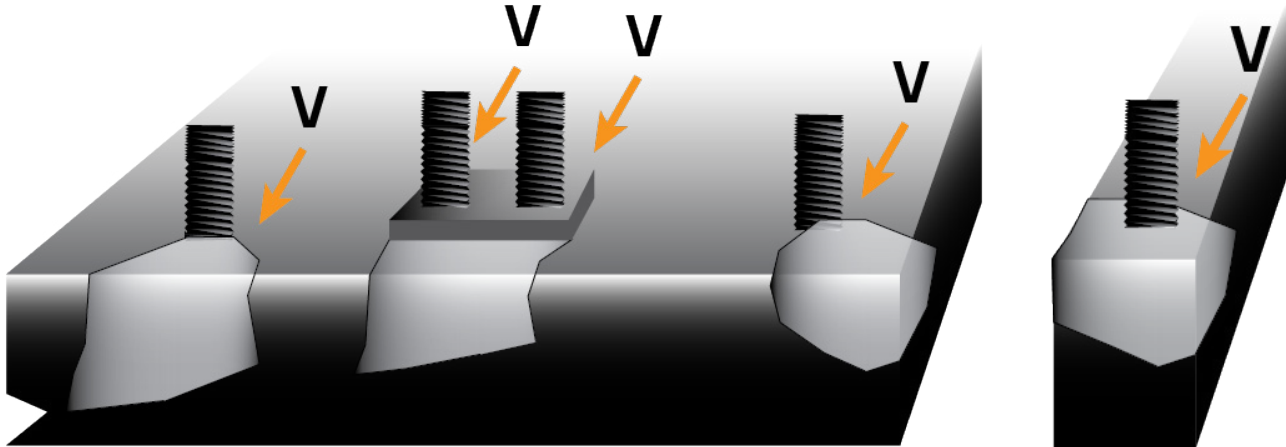

Interaction

- The controlling tension and shear proofs have to be superimposed because there may be interaction between them.

Adhesive anchors

- Concrete breakout (tension): additional factor $\gamma_{seismic} = 0.75$
- Bond strength: additional factor $\gamma_{N,seis}$
- Bond strength: additional factor $\gamma_{seismic} = 0.75$
- Steel failure (shear): additional factor $\gamma_{N,seis}$

EXAMPLE WORKFLOW

EXAMPLE

The aim of this example is to find a suitable anchor which will support the construction element with the parameters outlined below.

- Cracked concrete, 4000 psi compressive strength
- No concrete reinforcement
- Seismic category D
- Downward installation (in the floor)
- Water filled holes
- Maximum short term temperature: 110° F
- Maximum long term temperature: 68° F
- Periodic inspection
- Anchor plate: 10" x 7" x 0.25"
- Group of 4 anchors, spacing: 7" x 4"
- No relevant concrete edges
- Concrete thickness: 8"
- Tension Nu: 6000 lb
- Shear Vuy: 3000 lb
- Shear Vuz: 3000 lb
- Load combination according to ACI 318 Chapter 9.2



To get comfortable with using the software it is advised to follow along directly with the instructions. To begin start the software by using its desktop or start menu shortcut. The software will start with a default project which we will use as the baseline for this example. By clicking the "New project" button you can revert to the default project at anytime. If you made any changes so far you will be prompted to save or discard those changes before proceeding.

Note: This step is entirely optional. You don't have to enter anything in the project information tab.

Use the primary navigation to open the project information tab. In a real project you would probably enter all the contact information for contractor, sub-contractor and engineer. In this example we will just enter a project name and number as seen below. This information will be shown in the print out later.

Project

Name	<input type="text" value="AnchorFix 1"/>
Number	<input type="text" value="01"/>
Object	<input type="text" value="Threaded"/>
Deadline	<input type="text" value="20/06/2014"/>
Comments	<input type="text"/>

Now it is time to input the actual calculation parameters. This topic is split up by tab of the primary navigation. Most of these values can be changed directly in the 3D graphic. In this example we will use the input area on the left side instead.

EXAMPLE WORKFLOW

MATERIAL

Use the primary navigation to open the material tab. The material tab deals with concrete and reinforcement properties. The material tab is split into boxes to group user inputs logically. We will go through the boxes from top to bottom.

1. Concrete (Normal Weight)

The default project is initialized with the following values:

▶ Concrete

Concrete class	2500 psi	▼
Zone	non cracked concrete	▼

To meet our requirements we have to change all values:

- Select “4000 psi” from the “Concrete Compressive Strength” drop-down menu.
- Select “Cracked Concrete (Tension Zone)” from the “Zone” drop-down menu.

2. Concrete Reinforcement

No changes are necessary here because the default assumption is that there is no reinforcement.

▶ Reinforcement

<input type="checkbox"/>	Reinforcement of axial forces
<input type="checkbox"/>	Reinforcement of lateral forces
<input type="checkbox"/>	Enclosed in stirrups with distance of no more than 4 inches

▶ Conditions

Temperature range	110°F 68°F	▼
Inspection	Continuous	▼
Conditioning	Dry	▼

To meet our requirements we have to change the values:

- Select “110° F | 68° F” from the “Temperature range” drop-down menu. The first value denotes maximum short term temperature while the second value denotes maximum long term temperature.
- Select “Water-filled” from the “Installation Condition” drop-down menu. Installation condition refers to the drill hole’s condition during the installation process.

EXAMPLE WORKFLOW

GEOMETRY

Use the primary navigation to open the geometry tab. The geometry tab deals with anchor arrangements, concrete dimensions and anchor plate dimensions.

1. Anchor

The default option is single anchor without eccentricity (displacement) which means the anchor will be located in the anchor plate's center.

▶Anchor

The screenshot shows a software interface for configuring a single anchor. At the top, a dropdown menu is set to "Single Anchor without slotted hole". Below this, under the heading "Eccentricity", there are two input fields: "y" with a value of "0.000 inch" and "z" with a value of "0.000 inch". At the bottom, there is an "Angle" field with a value of "0°".

To meet our requirement (group of 4 anchors, spacing: 7" x 4") perform the following steps:

- Select "Group of four without slotted holes" from the anchor arrangement drop-down menu.
- Type "7" in the y1 input field and confirm by pressing the enter or return key.
- Type "4" in the z1 input field and confirm by pressing the enter or return key.

The screenshot shows the software interface for configuring a group of four anchors. The dropdown menu is set to "Group of four without slotted holes". Under the heading "Eccentricity", the "y" and "z" input fields are still present and set to "0.000 inch". Below this, under the heading "Centre to centre distance", there are two new input fields: "y1" with a value of "7.000 inch" and "z1" with a value of "4.000 inch". The "Angle" field at the bottom remains set to "0°".

Notice that the anchor spacing input fields only became visible after selecting an anchor arrangement with more than one anchor. Depending on the selected anchor arrangement there may be fewer or more anchor spacing input fields.

EXAMPLE WORKFLOW

GEOMETRY

2. Edge Distances / Concrete Thickness

The default project is initialized with the following values:

▶ Edge distances / member thickness

<input type="checkbox"/> Edge left	
<input type="checkbox"/> Edge right	
<input type="checkbox"/> Edge top	
<input type="checkbox"/> Edge bottom	
Member thickness	<input type="text" value="10.000 inch"/>

Since we will not be considering any concrete edges in this example there is only one value to change:

- Type “8” in the “Member thickness” input field and confirm by pressing the enter or return key.

▶ Edge distances / member thickness

<input type="checkbox"/> Edge left	
<input type="checkbox"/> Edge right	
<input type="checkbox"/> Edge top	
<input type="checkbox"/> Edge bottom	
Member thickness	<input type="text" value="8.000 inch"/>

3. Anchor plate dimensions

The default project is initialized with the following values:

▶ Anchor plate dimensions

Width of baseplate	y	<input type="text" value="10.000 inch"/>
Length of baseplate	z	<input type="text" value="10.000 inch"/>
Fixture thickness		<input type="text" value="0.375 inch"/>

To meet our requirements we have to change all values that do not already match:

- Type “7” in the “Anchor plate length” input field and confirm by pressing the enter or return key.
- Type “0.25” in the “Anchor plate thickness” input field and confirm by pressing the enter or return key.

▶ Anchor plate dimensions

Width of baseplate	y	<input type="text" value="10.000 inch"/>
Length of baseplate	z	<input type="text" value="7.000 inch"/>
Fixture thickness		<input type="text" value="0.250 inch"/>

Take note how the fraction 1/4 has to be entered using its decimal value of 0.25. This applies to all values and input fields throughout the software.

EXAMPLE WORKFLOW

LOAD

1. Load

The default project is initialized without any loads:

▶ Load

Axial force	N_u	0 lb
Lateral forces	V_{uy}	0 lb
	V_{uz}	0 lb
Torques	M_{uy}	0 ft-lb
	M_{uz}	0 ft-lb
Shear load conditions		
<input type="checkbox"/> Use anchors with built-up grout pads		

▶ Load

Axial force	N_u	6000 lb
Lateral forces	V_{uy}	3000 lb
	V_{uz}	3000 lb
Torques	M_{uy}	0 ft-lb
	M_{uz}	0 ft-lb
Shear load conditions		
<input type="checkbox"/> Use anchors with built-up grout pads		

Enter the given design loads to match our requirements:

- Type “6000” in the N_u input field and confirm by pressing the enter or return key.
- Type “3000” in the V_{uy} input field and confirm by pressing the enter or return key.
- Type “3000” in the V_{uz} input field and confirm by pressing the enter or return key.

1. Load combinations

No changes are necessary here because the default assumption is that loads were combined according to ACI 318 Chapter 9.2.

▶ Load combination

ACI 318 chapter 9.2	▼
<input type="checkbox"/> Moderate to high seismic danger	

As we have specified seismic category D we need to check the moderate to high seismic danger box.

EXAMPLE WORKFLOW

ANCHOR SELECTION

Now that all values have been entered click on the “Calculate” button to open the result overview tab and perform the actual calculations. The result overview tab shows all available anchors, documents for the selected anchor and calculation results.

By default all available anchors will be calculated. Use filters (top left side) to narrow down the list of considered anchors. On your first calculation the anchor at the top of the left hand side list will be selected. After that your selection will be remembered between calculations. You have access to corresponding documents (like the ESR) for the selected anchor in the bottom left “Anchor” box.

Anchor

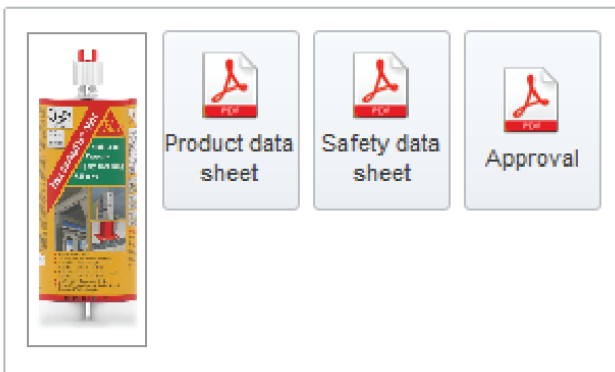

All results are shown in a table on the right side which includes details about the anchor, its percentage utilization and suitability. Generally you will want to select an anchor near the top of that table because by default suitable anchors with the highest utilization will be on top. They are followed by overloaded anchors and finally unsuitable anchors. See “Calculation Results” for more details. Below the result list you will see the resulting forces per anchor. Next to them you will see calculation details in the form of a breakdown by failure mode (proof).

Name	Steel	Diameter	hef	Total capacity	Results
AnchorFix-3001	Carbon A615-40	#7	4"	86.91 %	Anchor acceptable
AnchorFix-3001	Carbon A615-60	#7	4"	86.91 %	Anchor acceptable
AnchorFix-3001	Stainless F593 CW	7/8"	4"	86.91 %	Anchor acceptable
AnchorFix-3001	Stainless F593 SH	7/8"	4"	86.91 %	Anchor acceptable
AnchorFix-3001	Carbon A193 B7	1"	4"	86.91 %	Anchor acceptable
AnchorFix-3001	Carbon A36	1"	4"	86.91 %	Anchor acceptable
AnchorFix-3001	Carbon A615-40	#8	4"	86.91 %	Anchor acceptable
AnchorFix-3001	Carbon A615-60	#8	4"	86.91 %	Anchor acceptable
AnchorFix-3001	Stainless F593 CW	1"	4"	86.91 %	Anchor acceptable
AnchorFix-3001	Stainless F593 SH	1"	4"	86.91 %	Anchor acceptable
AnchorFix-3001	Carbon A193 B7	1 1/4"	5"	71.39 %	Anchor acceptable
AnchorFix-3001	Carbon A36	1 1/4"	5"	71.39 %	Anchor acceptable
AnchorFix-3001	Carbon A615-40	#10	5"	71.39 %	Anchor acceptable
AnchorFix-3001	Carbon A615-60	#10	5"	71.39 %	Anchor acceptable
AnchorFix-3001	Stainless F593 CW	1 1/4"	5"	71.39 %	Anchor acceptable
AnchorFix-3001	Stainless F593 SH	1 1/4"	5"	71.39 %	Anchor acceptable
AnchorFix-3001	Stainless F593 SH	3/8"	7 1/2"	104.36 %	Anchor overloaded
AnchorFix-2	Carbon A307 A	1/2"	6"	114.96 %	Anchor overloaded
AnchorFix-2	Carbon A36	1/2"	6"	117.12 %	Anchor overloaded

EXAMPLE WORKFLOW

PRINT OUT

Use the primary navigation to open the print preview tab. The print preview tab shows a report containing all user inputs and calculation results as well as information about the selected anchor. Use the print options on the left side to configure the print out to your liking.

There you will also find controls to navigate the preview displayed on the right. When you are satisfied print the report or save it as a PDF document.

▶ **Print preview**



The print out contains all user inputs as well as the 3D graphic to illustrate the use case. Additionally there are details about the selected anchors and optionally your project information. The “Verification” sections contains details (including the used formulas) for every relevant proof.

Do not forget to save your project file as well so you can recalculate or change it later without having to enter all values again. Use the “Save” button to do this.

REBAR CALCULATION PROGRAM

GENERAL

The user interface is divided into 5 areas:

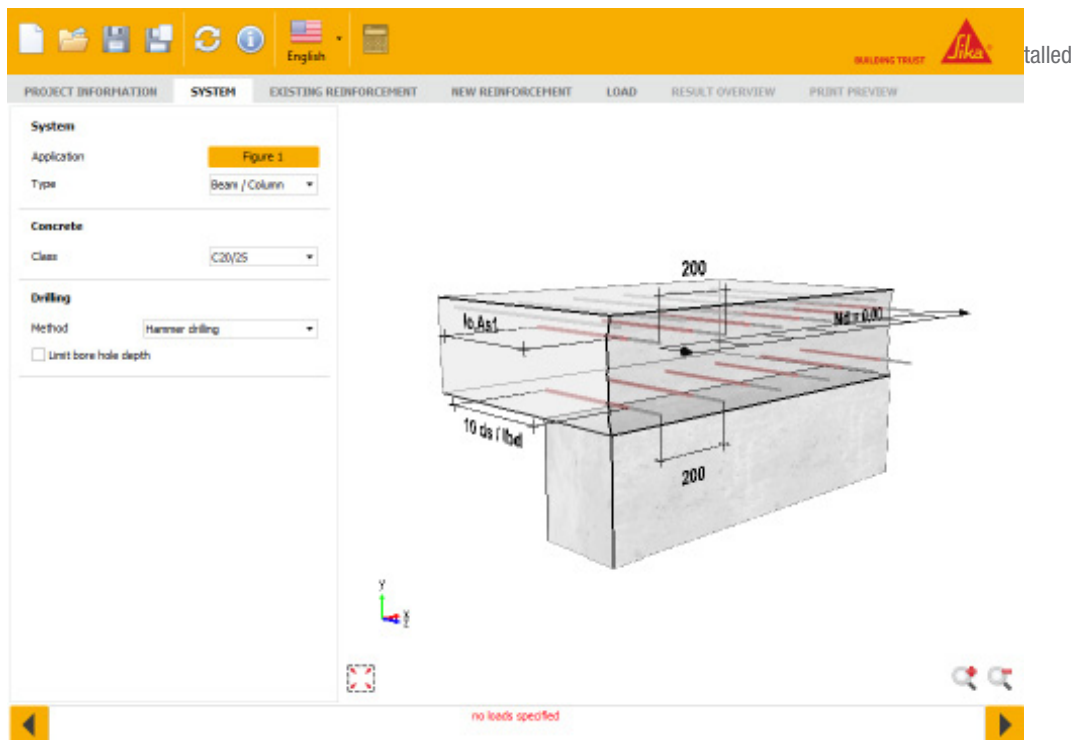

- (1) Menu area
- (2) List of possible reinforcing bar diameters
- (3) Area for input and output
- (4) Preview window
- (5) Status bar

The content of these areas will be described within the next chapters.

- Technical Report for Post Installed Rebar Connections TR23

The user interface is divided into 5 areas:







- (1) Menu area
- (2) List of possible reinforcing bar diameters
- (3) Area for input and output
- (4) Preview window
- (5) Status bar

The content of these areas will be described within the next chapters.

REBAR CALCULATION PROGRAM

MENU AREA

In this area the most important icons can be found:

	Start new project
	Open project
	Save Project
	Save Project as
	Various information regarding the program. Amongst others you can find the version number of your software here.
	Switch languages. On principle, you can always switch languages. However, if the result overview or the print preview is being shown, the recalculation of the project is necessary.
	Calculate the current project. This icon might be deactivated if input data are missing or faulty.

LIST OF POSSIBLE REINFORCING BAR DIAMETERS

In this all diameters which can be used as post installed rebar connections according to the European Technical Assessment can be found in this list. Per default all diameters are selected and the software would carry out the calculations with all diameters. However, you can limit the selection in order to verify an existing rebar connection or to use only specific diameters.

INPUT AND OUTPUT

In this area up to five tabs may be visible

- Project information
- Numeric input
- Graphic input
- Result overview (this tab is not visible if no valid calculation results exist)
- Short result preview (this tab is not visible if no valid calculation results exist)

Ideally, you should work through the software tabs from left to right. This will lead you through all relevant input parameters up to the print preview. The only exception to this is the tab 'Numeric input / Graphic input'. Here you can choose whether you want to enter the data in table form or rather in a 3D environment. Of course you can switch between the two at any time. All changes will be refreshed simultaneously. The content of the input pages will be explained in the following chapters.

REBAR CALCULATION PROGRAM

PROJECT INFORMATION

The screenshot displays the 'PROJECT INFORMATION' tab of the Rebar Calculation Program. The interface features a yellow header bar with icons for file operations, a language dropdown set to 'English', and the Sika logo. Below the header, a navigation bar includes tabs for 'PROJECT INFORMATION', 'SYSTEM', 'EXISTING REINFORCEMENT', 'NEW REINFORCEMENT', 'LOAD', 'RESULT OVERVIEW', and 'PRINT PREVIEW'. The main content area is divided into four columns for 'Project', 'Contractor', 'Sub-Contractor', and 'Engineer'. Each column contains input fields for Name, Number, Address, Telephone, Fax, and Email. The 'Project' column also includes a 'Deadline' dropdown menu currently showing '12/08/2015'. A large 'Comments' text area is located at the bottom of the form. The interface is framed by a standard Windows-style scrollbar at the bottom.

Please enter all relevant project data in this form. The user name will be read from the Windows user name. You might change the date in order to date the project ahead or back. In comments you might add calculation assumptions, hints or assumptions. All these data will be shown at the beginning of the printout.

REBAR CALCULATION PROGRAM

SYSTEM: SYSTEM SELECTION

By clicking the application button in the system tab you can select an application. The software will then initialise a new graphic and the relevant inputs for the selected application.

PROJECT INFORMATION	SYSTEM	EXISTING REI
System		
Application	Figure 1	
Type	Beam / Column	
Concrete		
Class	C20/25	
Drilling		
Method	Hammer drilling	
<input type="checkbox"/> Limit bore hole depth		

The applications available for selection are those given by EOTA TR023:

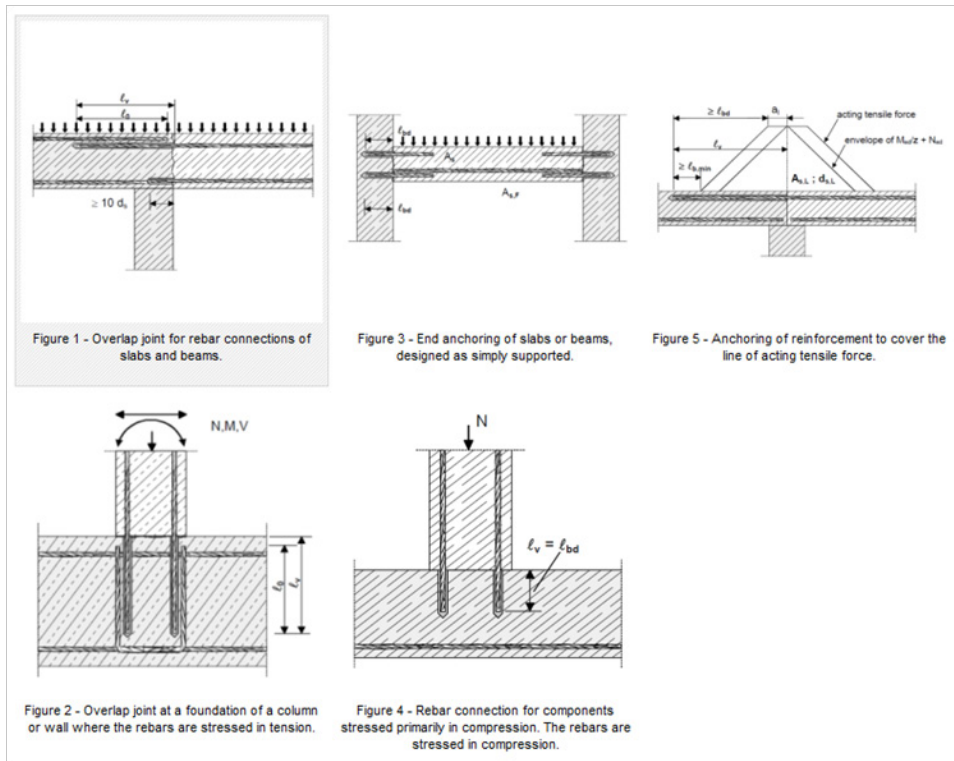

REBAR CALCULATION PROGRAM

EXISTING REINFORCEMENT

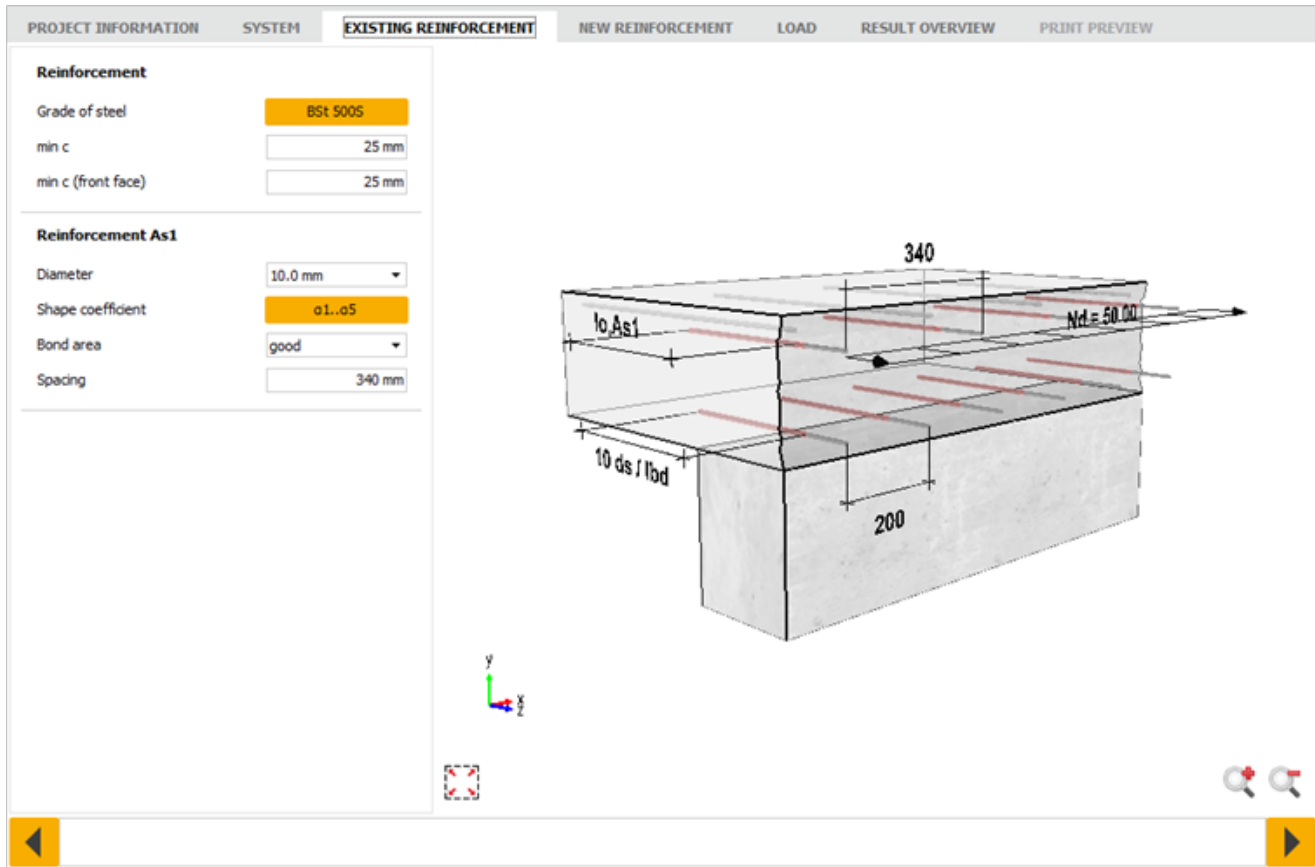

The existing reinforcement tab allows the user to input details of existing reinforcement including:

- Grade of steel
- The minimum cover
- Diameter of the steel – select the diameter from the dropdown menu
- Shape coefficient of the rebar
- The condition of the bond area – select the condition from the dropdown menu
- Rebar spacing

By clicking the button displaying the currently selected steel grade it is possible to select a new steel grade from the menu:

REBAR CALCULATION PROGRAM

Reinforcement steel

Designation	Profile	fbd C12/15	fbd C16/20	fbd C20/25	fbd C25/30	fbd C30/37	fbd C35/45	fbd C40/50	fbd C45/55	fbd C50/60	f _{yk}
<input checked="" type="radio"/> BSt 500S	ribbed	1.60	2.00	2.30	2.70	3.00	3.40	3.70	4.00	4.30	500.00
<input type="radio"/> BSt 500M	ribbed	1.60	2.00	2.30	2.70	3.00	3.40	3.70	4.00	4.30	500.00
<input type="radio"/> BSt 420S	ribbed	1.60	2.00	2.30	2.70	3.00	3.40	3.70	4.00	4.30	420.00
<input type="radio"/> BSt 500PK	ribbed	1.10	1.30	1.50	1.60	1.80	2.00	2.20	2.30	2.50	500.00
<input type="radio"/> BSt 550PK	ribbed	1.10	1.30	1.50	1.60	1.80	2.00	2.20	2.30	2.50	550.00
<input type="radio"/> BSt 500GK	Smooth	0.90	1.00	1.10	1.20	1.30	1.40	1.50	1.60	1.70	500.00
<input type="radio"/> BSt 550GK	Smooth	0.90	1.00	1.10	1.20	1.30	1.40	1.50	1.60	1.70	550.00
<input type="radio"/> BSt 340GU	Smooth	0.90	1.00	1.10	1.20	1.30	1.40	1.50	1.60	1.70	340.00
<input type="radio"/> BSt 220GU	Smooth	0.90	1.00	1.10	1.20	1.30	1.40	1.50	1.60	1.70	220.00

OK Cancel

The shape coefficient of the rebar may be changed by clicking the button next to “shape coefficient” displaying the currently selected alpha factors.

Anchages

Type of bars

Straight bar ends Angled hooks Hooks Loops

Transverse reinforcement

No transverse reinforcement Welded-on transverse reinforcement

Lateral pressure

Lateral pressure N/mm²

OK Cancel

REBAR CALCULATION PROGRAM

NEW REINFORCEMENT

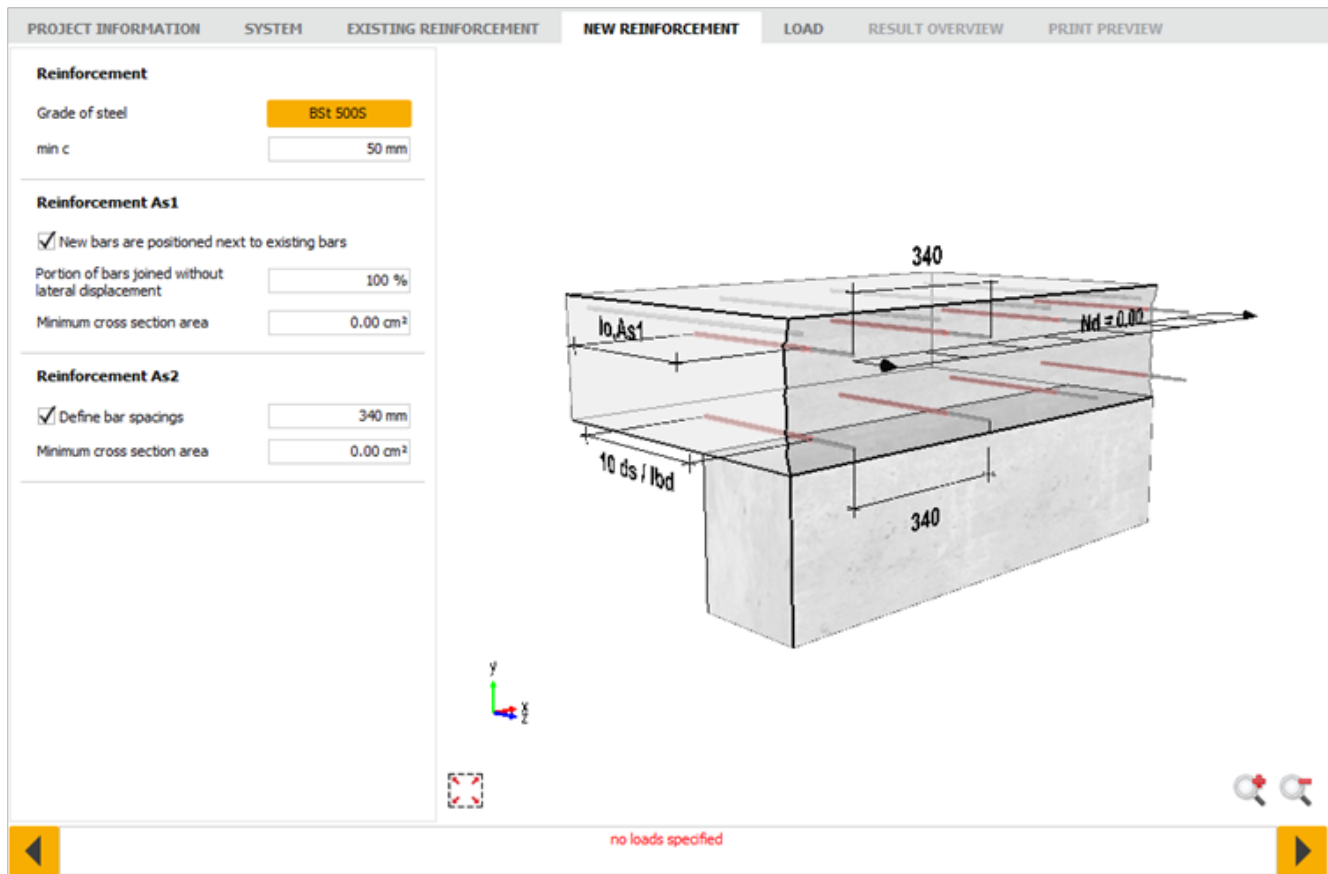

The new reinforcement tab allows the user to input details of new reinforcement to be installed including:

- Grade of steel
- The minimum cover
- If the new reinforcement is to be placed next to existing rebar
- The proportion of the rebars joined without lateral displacement
- The minimum cross sectional area of steel to be used for new reinforcement
- Define the rebar spacing

By clicking the button displaying the currently selected steel grade it is possible to select a new steel grade from the menu:

Designation	Profile	fbd C12/15	fbd C16/20	fbd C20/25	fbd C25/30	fbd C30/37	fbd C35/45	fbd C40/50	fbd C45/55	fbd C50/60	f _{yk}
BSt 500S	ribbed	1.60	2.00	2.30	2.70	3.00	3.40	3.70	4.00	4.30	500.00

REBAR CALCULATION PROGRAM

LOAD

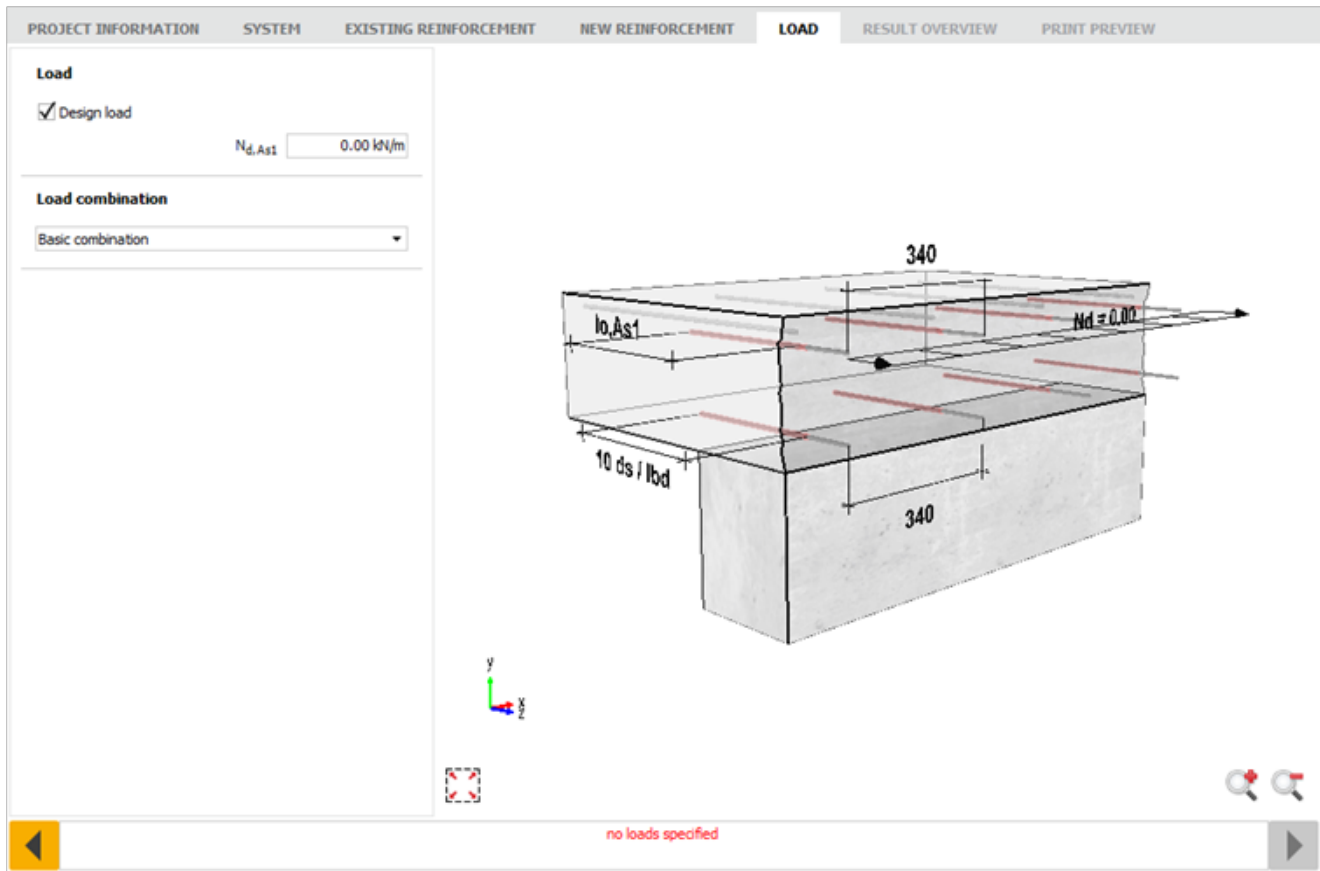

The load tab allows the user to input load values acting on the new reinforcement. By checking the design load box the user can input the data for design loads. By un-checking the design load box the user can enter data for characteristic loads.

The load combination may also be selected using the dropdown menu to choose between the basic combination and extraordinary combination of loads.

REBAR CALCULATION PROGRAM

RESULTS OVERVIEW

PROJECT INFORMATION SYSTEM EXISTING REINFORCEMENT NEW REINFORCEMENT LOAD **RESULT OVERVIEW** PRINT PREVIEW

Name
AnchorFix-2



AnchorFix-2

Approval ▾

Name	Diameter	Spacing	l0 / lbd	Bore hole depth	Utilization	Results
As1	8.0 mm	340 mm	319 mm	344 mm	-	Diameter not applicable
As1	10.0 mm	340 mm	319 mm	344 mm	-	Diameter not applicable
As1	12.0 mm	340 mm	383 mm	408 mm	-	Diameter not applicable
As1	14.0 mm	340 mm	447 mm	472 mm	-	Diameter not applicable
As1	16.0 mm	340 mm	511 mm	536 mm	-	Diameter not applicable
As1	20.0 mm	340 mm	638 mm	663 mm	-	Diameter not applicable
As1	25.0 mm	340 mm	798 mm	823 mm	-	Diameter not applicable
As1	28.0 mm	340 mm	894 mm	919 mm	-	Diameter not applicable
As1	32.0 mm	340 mm	1021 mm	1046 mm	-	Diameter not applicable

Name	Diameter	Spacing	l0 / lbd	Bore hole depth	Utilization	Results
As2	8.0 mm	340 mm	171 mm	171 mm	0.00 %	Diameter acceptable
As2	10.0 mm	340 mm	213 mm	213 mm	0.00 %	Diameter acceptable
As2	12.0 mm	340 mm	256 mm	256 mm	0.00 %	Diameter acceptable
As2	14.0 mm	340 mm	298 mm	298 mm	0.00 %	Diameter acceptable
As2	16.0 mm	340 mm	341 mm	341 mm	-	Diameter not applicable
As2	20.0 mm	340 mm	426 mm	426 mm	-	Diameter not applicable
As2	25.0 mm	340 mm	532 mm	532 mm	-	Diameter not applicable
As2	28.0 mm	340 mm	596 mm	596 mm	-	Diameter not applicable
As2	32.0 mm	340 mm	681 mm	681 mm	-	Diameter not applicable

As1: The existing concrete cover is smaller than the one acceptable at the applied drilling method of 63 mm.

The results overview tab displays all of the results for the selected parameters. The results shown in green are acceptable, whereas those shown in red are not acceptable. Error messages are also shown in the message area at the bottom of the screen to explain the reason why the selected result may be unacceptable.

Click on a result to select it. This allows a print preview to be generated.

An image of the selected product is shown in the bottom left corner of the screen. By clicking the button next to this the user can access the relevant documents for this product.

REBAR CALCULATION PROGRAM

PRINT PREVIEW

The screenshot shows the 'PRINT PREVIEW' tab of the Sika AnchorFix-2 rebar calculation program. The interface is divided into a left sidebar and a main content area.

Left Sidebar:

- Print preview:** Includes icons for printing and saving as PDF.
- Page / Zoom:** Shows page 1 of 5 and a zoom level of 100%. Navigation arrows are present.
- Date:** Options include 'without', 'Today' (selected), and 'Selected date' (12/06/2015).
- Print options:** A checkbox for 'Print project data' is currently unchecked.

Main Content Area:

- Project Information:** Project, Project number, and Contact details. Version 1.0.0.0, 12/06/2015.
- Product information:** Sika AnchorFix-2. Approval: ETA-09/0112 AnchorFix-2. A small image of the product is shown.
- Table:**

	A61	A62
Diameter	16.0 mm	12.0 mm
Drill hole depth	536 mm	256 mm
Nominal drill bit diameter	20 mm	16 mm
Annulus volume per bore hole	84.24 ml	29.89 ml
- Text:** This calculation does not take into account of variation in hole diameters and assumes the hole diameter specified is the hole diameter drilled. No allowance for waste is made in this calculation. Waste can include product lost in the mixer nozzle, product lost before a correct mixture is achieved and product lost when holes have been overfilled.
- System:**

System	Overlap joint for rebar connections of slabs and beams.
Application	Beam / Column
Concrete Class	C30/35
Drilling Method	Hammer drilling
- Existing reinforcement:**

Reinforcement		BSt 500S
Grade of steel		25 mm
Concrete cover	16/18, c	25 mm
Concrete cover - front face	16/18, c	25 mm

Footer: As1: The existing concrete cover is smaller than the one acceptable at the applied drilling method of 63 mm.

The print preview page allows the user to either directly print a hard copy of the selected solution or to save the calculation as a PDF file.

The page / zoom area allows the user to zoom in and out of the calculation document or to skip through the pages of the calculation using the backwards and forwards arrows.

It is possible to select the date shown on the calculation as either: no date (without), the current date (today) or a user defined date (select date) in the date area of the tab.

By checking the print project data box, the user can choose to include the data entered previously in the project information tab in the calculation.

Sika Services AG
Corporate Technical Department
Speckstrasse 22
CH-8330 Pfäffikon ZH
Switzerland
www.sika.com

Version given by:
Marco B. Poltéra

Phone: +41 58 436 23 73
Fax: +41 58 436 23 77
Mail: poltera.marco@ch.sika.com

Method Statement / Design Manual
Sika AnchorFix®
10 2015, 00
850 42 06

English/Sika Services AG

